				Spessore Parete Tubo (mm)							
TRAFILATO	TIPO	De (mm)	X	1	1,5	2	2,5	3	3,5	4	5
BONDERIZZATO	TT	4		600							
BONDERIZZATO	TT	5		450							
BONDERIZZATO	TT	6		340	600	880					
BONDERIZZATO	TT	8		260	430	530					
BONDERIZZATO	TT	10		210	330	470	630				
BONDERIZZATO	TT	12		170	260	350	500	650			
BONDERIZZATO	TT	14		140	220	300	410	540			
BONDERIZZATO	TT	15		130	200	280	380	500			
BONDERIZZATO	TT	16		120	190	260	340	450			
BONDERIZZATO	TT	18		100	170	220	280	350			
BONDERIZZATO	TT	20		80	140	200	250	320		500	
BONDERIZZATO	TT	22		70	130	170	210	270			
BONDERIZZATO	TT	25			110	150	190	250		350	480
BONDERIZZATO	TT	28		50	90	130	160	210		300	430
BONDERIZZATO	TT	30			90	130	150	190		280	
BONDERIZZATO	TT	35			80	100	120	150		230	320
BONDERIZZATO	TT	38				80	100	140		220	320
BONDERIZZATO	TT	42				80		120		180	250

				Spessore Parete Tubo (mm)							
TRAFILATO	TIPO	D.e.(mm)	X	1	1,5	2	2,5	3	3,5	4	5
ZINCATO	TZ	4		600							
ZINCATO	TZ	6		450							
ZINCATO	TZ	8		340	600	880					
ZINCATO	TZ	10		260	430	530					
ZINCATO	TZ	12		210	330	470	630				
ZINCATO	TZ	14		170	260	350	500	650			
ZINCATO	TZ	15		140	220	300	410	540			
ZINCATO	TZ	16		130	200	280	380	500			
ZINCATO	TZ	18		120	190	260	340	450			
ZINCATO	TZ	20		100	170	220	280	350			
ZINCATO	TZ	22		80	140	200	250	320		500	
ZINCATO	TZ	25		70	130	170	210	270			
ZINCATO	TZ	28			110	150	190	250		350	480
ZINCATO	TZ	30		50	90	130	160	210		300	430
ZINCATO	TZ	35			90	130	150	190		280	
ZINCATO	TZ	38			80	100	120	150		230	320
ZINCATO	TZ	42				80	100	140		220	320

DADO DI SERRAGGIO
NUT
TUERCAS
UBERWURFMUTTERN

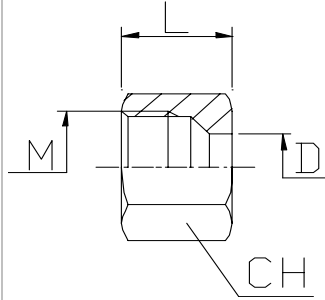
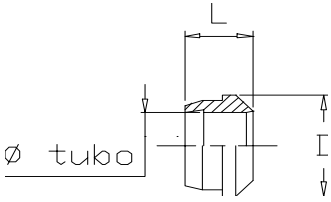

TN81	CODICE 1	CODICE 2	L1	L2	L3	L4	CH1	CH2	SERIE	TUBO	DADO	M
	TN81-4LL	1002.01							LL	4	8X1	
	TN81-5LL	1002.-							LL	5	10X1	
	TN81-6LL	1002.02							LL	6	10X1	
	TN81-8LL	1002.03							LL	8	12X1	
	TN81-10LL	1002.-							LL	10	14X1	
	TN81-12LL	1002.-							LL	12	16X1	
	TN81-15LL	1002.-							LL	15	0	
	TN81-18LL	1002.-							LL	18	0	
	TN81-22LL	1002.-							LL	22	0	
	TN81-6L	1002.04							L	6	12X1,5	
	TN81-8L	1002.05							L	8	14X1,5	
	TN81-10L	1002.06							L	10	16X1,5	
	TN81-12L	1002.07							L	12	18X1,5	
	TN81-15L	1002.08							L	15	22X1,5	
	TN81-18L	1002.09							L	18	26X1,5	
	TN81-22L	1002.10							L	22	30X2	
	TN81-28L	1002.11							L	28	36X2	
	TN81-35L	1002.12							L	35	45X2	
	TN81-42L	1002.13							L	42	52X2	
	TN81-6S	1002.14							S	6	14X1,5	
	TN81-8S	1002.15							S	8	16X1,5	
	TN81-10S	1002.16							S	10	18X1,5	
	TN81-12S	1002.17							S	12	20X1,5	
	TN81-14S	1002.18							S	14	22X1,5	
	TN81-16S	1002.19							S	16	24X1,5	
	TN81-20S	1002.20							S	20	30X2	
	TN81-25S	1002.21							S	25	36X2	
	TN81-30S	1002.22							S	30	42X2	
	TN81-38S	1002.23							S	38	52X2	

ANELLO DI SERRAGGIO CUTTING RING ANILLOS SCHNELDRINGE													
TN88	CODICE 1	CODICE 2	L1	L2	L3	L4	CH1	CH2	SERIE	TUBO	DADO	M	
	TN88-4LL	1001.01							LL	4			
	TN88-5LL	1001.-							LL	5			
	TN88-6LL	1001.02							LL	6			
	TN88-8LL	1001.03							LL	8			
	TN88-10LL	1001.-							LL	10			
	TN88-12LL	1001.-							LL	12			
	TN88-15LL	1001.-							LL	15			
	TN88-18LL	1001.-							LL	18			
	TN88-22LL	1001.-							LL	22			
	TN88-6LS	1001.04								LS	6		
	TN88-8LS	1001.05								LS	8		
	TN88-10LS	1001.06								LS	10		
	TN88-12LS	1001.07								LS	12		
	TN88-15L	1001.08								L	15		
	TN88-18L	1001.09								L	18		
	TN88-22L	1001.10								L	22		
	TN88-28L	1001.11								L	28		
	TN88-35L	1001.12								L	35		
	TN88-42L	1001.13								L	42		
	TN88-14S	1001.18								S	14		
	TN88-16S	1001.19								S	16		
	TN88-20S	1001.20								S	20		
	TN88-25S	1001.21								S	25		
	TN88-30S	1001.22								S	30		
	TN88-38S	1001.23								S	38		

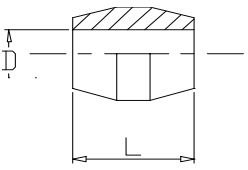
ANELLO DI SERRAGGIO CUTTING RING ANILLOS SCHNELDRINGE												
BIC	CODICE 1	CODICE 2	L1	L2	L3	L4	CH1	CH2	SERIE	TUBO	DADO	M
	BIC4			BIC				4				
	BIC5			BIC				5				
	BIC6			BIC				6				
	BIC8			BIC				8				
	BIC10			BIC				10				
	BIC15			BIC				15				

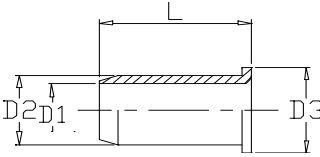
ANELLO DI RINFORZO PIPE INSERTS ANILLO VERSTARKUNGSHULSEN												
BUO	CODICE 1	CODICE 2	L1	L2	L3	L4	CH1	CH2	SERIE	TUBO	DADO	M
	BUO			BUO				4				
	BUO			BUO				5				
	BUO			BUO				6				
	BUO			BUO				7				
	BUO			BUO				8				
	BUO			BUO				9				
	BUO			BUO				10				

RACCORDO INTERMEDIO DIRITTO
STRAIGHT COUPLING
RACOR UNION RECTA TUBO-TUBO
GERADE VERSCHRAUBUNGEN

TN98	CODICE 1	CODICE 2	L1	L2	L3	L4	CH1	CH2	SERIE	TUBO	DADO	M
	TN98-4LL	1035.01							LL	4	8X1	
	TN98-5LL	1035.-							LL	5	10X1	
	TN98-6LL	1035.02							LL	6	10X1	
	TN98-8LL	1035.03							LL	8	12X1	
	TN98-10LL	1035.-							LL	10	14X1	
	TN98-12LL	1035.-							LL	12	16X1	
	TN98-15LL	1035.-							LL	15	0	
	TN98-18LL	1035.-							LL	18	0	
	TN98-22LL	1035.-							LL	22	0	
	TN98-6L	1035.04							L	6	12X1,5	
	TN98-8L	1035.05							L	8	14X1,5	
	TN98-10L	1035.06							L	10	16X1,5	
	TN98-12L	1035.07							L	12	18X1,5	
	TN98-15L	1035.08							L	15	22X1,5	
	TN98-18L	1035.09							L	18	26X1,5	
	TN98-22L	1035.10							L	22	30X2	
	TN98-28L	1035.11							L	28	36X2	
	TN98-35L	1035.12							L	35	45X2	
	TN98-42L	1035.13							L	42	52X2	
	TN98-6S	1035.14							S	6	14X1,5	
	TN98-8S	1035.15							S	8	16X1,5	
	TN98-10S	1035.16							S	10	18X1,5	
	TN98-12S	1035.17							S	12	20X1,5	
	TN98-14S	1035.18							S	14	22X1,5	
	TN98-16S	1035.19							S	16	24X1,5	
	TN98-20S	1035.20							S	20	30X2	
	TN98-25S	1035.21							S	25	36X2	
	TN98-30S	1035.22							S	30	42X2	
	TN98-38S	1035.23							S	38	52X2	

**RACCORDO INTERMEDIO A GOMITO
 EQUAL ELBOWS
 RACOR UNION CODO TUBO-TUBO
 WINKEL-VERSCHRAUBUNGEN**

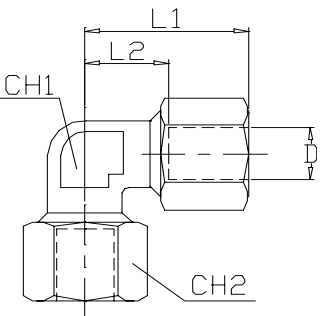
TN99	CODICE 1	CODICE 2	L1	L2	L3	L4	CH1	CH2	SERIE	TUBO	DADO	M
	TN99-4LL	1038.01							LL	4	8X1	
	TN99-5LL	1038.-							LL	5	10X1	
	TN99-6LL	1038.02							LL	6	10X1	
	TN99-8LL	1038.03							LL	8	12X1	
	TN99-10LL	1038.-							LL	10	14X1	
	TN99-12LL	1038.-							LL	12	16X1	
	TN99-15LL	1038.-							LL	15	0	
	TN99-18LL	1038.-							LL	18	0	
	TN99-22LL	1038.-							LL	22	0	
	TN99-6L	1038.04							L	6	12X1,5	
	TN99-8L	1038.05							L	8	14X1,5	
	TN99-10L	1038.06							L	10	16X1,5	
	TN99-12L	1038.07							L	12	18X1,5	
	TN99-15L	1038.08							L	15	22X1,5	
	TN99-18L	1038.09							L	18	26X1,5	
	TN99-22L	1038.10							L	22	30X2	
	TN99-28L	1038.11							L	28	36X2	
	TN99-35L	1038.12							L	35	45X2	
	TN99-42L	1038.13							L	42	52X2	
	TN99-6S	1038.14							S	6	14X1,5	
	TN99-8S	1038.15							S	8	16X1,5	
	TN99-10S	1038.16							S	10	18X1,5	
	TN99-12S	1038.17							S	12	20X1,5	
	TN99-14S	1038.18							S	14	22X1,5	
	TN99-16S	1038.19							S	16	24X1,5	
	TN99-20S	1038.20							S	20	30X2	
	TN99-25S	1038.21							S	25	36X2	
	TN99-30S	1038.22							S	30	42X2	
	TN99-38S	1038.23							S	38	52X2	

RACCORDO INTERMEDIO A TEE
EQUAL TEES
RACOR UNION EN T
T-VERSCHRAUBUNGEN

TN100	CODICE 1	CODICE 2	L1	L2	L3	L4	CH1	CH2	SERIE	TUBO	DADO	M
	TN100-4LL	1039.01							LL	4	8X1	
	TN100-5LL	1039.-							LL	5	10X1	
	TN100-6LL	1039.02							LL	6	10X1	
	TN100-8LL	1039.03							LL	8	12X1	
	TN100-10LL	1039.-							LL	10	14X1	
	TN100-12LL	1039.-							LL	12	16X1	
	TN100-15LL	1039.-							LL	15	0	
	TN100-18LL	1039.-							LL	18	0	
	TN100-22LL	1039.-							LL	22	0	
	TN100-6L	1039.04							L	6	12X1,5	
	TN100-8L	1039.05							L	8	14X1,5	
	TN100-10L	1039.06							L	10	16X1,5	
	TN100-12L	1039.07							L	12	18X1,5	
	TN100-15L	1039.08							L	15	22X1,5	
	TN100-18L	1039.09							L	18	26X1,5	
	TN100-22L	1039.10							L	22	30X2	
	TN100-28L	1039.11							L	28	36X2	
	TN100-35L	1039.12							L	35	45X2	
	TN100-42L	1039.13							L	42	52X2	
	TN100-6S	1039.14							S	6	14X1,5	
	TN100-8S	1039.15							S	8	16X1,5	
	TN100-10S	1039.16							S	10	18X1,5	
	TN100-12S	1039.17							S	12	20X1,5	
	TN100-14S	1039.18							S	14	22X1,5	
TN100-16S	1039.19							S	16	24X1,5		
TN100-20S	1039.20							S	20	30X2		
TN100-25S	1039.21							S	25	36X2		
TN100-30S	1039.22							S	30	42X2		
TN100-38S	1039.23							S	38	52X2		

**RACCORDO INTERMEDIO A CROCE
 EQUAL CROSSES
 RACOR UNION EN CRUZ TUBO-TUBO
 KREUZ-VERSCHRAUBUNGEN**

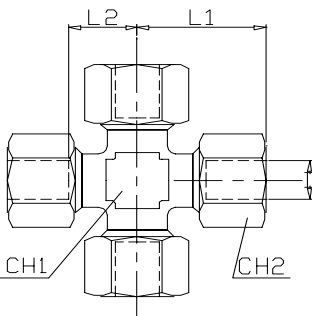
TN101	CODICE 1	CODICE 2	L1	L2	L3	L4	CH1	CH2	SERIE	TUBO	DADO	M	
	TN101-4LL	1040.01							LL	4	8X1		
	TN101-5LL	1040.-							LL	5	10X1		
	TN101-6LL	1040.02							LL	6	10X1		
	TN101-8LL	1040.03							LL	8	12X1		
	TN101-6L	1040.04							L	6	12X1,5		
	TN101-8L	1040.05							L	8	14X1,5		
	TN101-10L	1040.06							L	10	16X1,5		
	TN101-12L	1040.07							L	12	18X1,5		
	TN101-15L	1040.08							L	15	22X1,5		
	TN101-18L	1040.09							L	18	26X1,5		
	TN101-22L	1040.10							L	22	30X2		
	TN101-28L	1040.11							L	28	36X2		
	TN101-35L	1040.12							L	35	45X2		
	TN101-42L	1040.13							L	42	52X2		
	TN101-6S	1040.14								S	6	14X1,5	
	TN101-8S	1040.15								S	8	16X1,5	
	TN101-10S	1040.16								S	10	18X1,5	
	TN101-12S	1040.17								S	12	20X1,5	
	TN101-14S	1040.18								S	14	22X1,5	
	TN101-16S	1040.19								S	16	24X1,5	
	TN101-20S	1040.20								S	20	30X2	
	TN101-25S	1040.21								S	25	36X2	
	TN101-30S	1040.22								S	30	42X2	
TN101-38S	1040.23								S	38	52X2		

RACCORDO DO ATTRAVERSAMENTO DIRITTO
RACOR RECTO PASATABIQUE CON TUERCA
STRAIGHT BULKHEAD COUPLINGS
GERADE SCHOTTVERSCHRAUBUNGEN

TN102	CODICE 1	CODICE 2	L1	L2	L3	L4	CH1	CH2	SERIE	TUBO	DADO	M	
	TN102-6L	1036.04							L	6	12X1,5		
	TN102-8L	1036.05							L	8	14X1,5		
	TN102-10L	1036.06							L	10	16X1,5		
	TN102-12L	1036.07							L	12	18X1,5		
	TN102-15L	1036.08							L	15	22X1,5		
	TN102-18L	1036.09							L	18	26X1,5		
	TN102-22L	1036.10							L	22	30X2		
	TN102-28L	1036.11							L	28	36X2		
	TN102-35L	1036.12							L	35	45X2		
	TN102-42L	1036.13							L	42	52X2		
	TN102-6S	1036.14								S	6	14X1,5	
	TN102-8S	1036.15								S	8	16X1,5	
	TN102-10S	1036.16								S	10	18X1,5	
	TN102-12S	1036.17								S	12	20X1,5	
	TN102-14S	1036.18								S	14	22X1,5	
	TN102-16S	1036.19								S	16	24X1,5	
	TN102-20S	1036.20								S	20	30X2	
	TN102-25S	1036.21								S	25	36X2	
	TN102-30S	1036.22								S	30	42X2	
	TN102-38S	1036.23								S	38	52X2	

**RACCORDO DI ATTRAVERSAMENTO A GOMITO
 BULKHEAD ELBOWS
 RACOR EN CODO PASATABIQUE CON TUERCA
 WINKEL-SCHOTTVERSCHRAUBUNGEN**

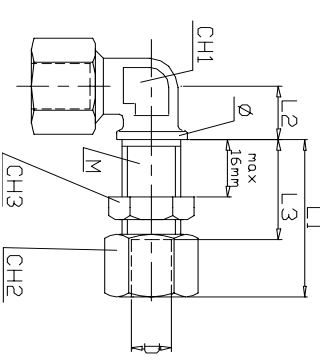
TN118	CODICE 1	CODICE 2	L1	L2	L3	L4	CH1	CH2	SERIE	TUBO	DADO	M	
	TN118-6L	1037.04							L	6	12X1,5		
	TN118-8L	1037.05							L	8	14X1,5		
	TN118-10L	1037.06							L	10	16X1,5		
	TN118-12L	1037.07							L	12	18X1,5		
	TN118-15L	1037.08							L	15	22X1,5		
	TN118-18L	1037.09							L	18	26X1,5		
	TN118-22L	1037.10							L	22	30X2		
	TN118-28L	1037.11							L	28	36X2		
	TN118-35L	1037.12							L	35	45X2		
	TN118-42L	1037.13							L	42	52X2		
	TN118-6S	1037.14								S	6	14X1,5	
	TN118-8S	1037.15								S	8	16X1,5	
	TN118-10S	1037.16								S	10	18X1,5	
	TN118-12S	1037.17								S	12	20X1,5	
	TN118-14S	1037.18								S	14	22X1,5	
	TN118-16S	1037.19								S	16	24X1,5	
	TN118-20S	1037.20								S	20	30X2	
	TN118-25S	1037.21								S	25	36X2	
	TN118-30S	1037.22								S	30	42X2	
	TN118-38S	1037.23								S	38	52X2	

RACCORDO INTERMEDIO DIRITTO RIDOTTO
REDUCED STRAIGHT COUPLING
RACOR UNION EN REDUCCION TUBO-TUBO
GERADE REDUZIERVERSCHRAUBUNG

TN98R	CODICE 1	CODICE 2	L1	L2	L3	L4	CH1	CH2	SERIE	TUBO	DADO	M
	TN98R-10/6L	1041.05							L	10	6	
	TN98R-10/8L	1041.06							L	10	8	
	TN98R-12/10L	1041.09							L	12	10	
	TN98R-12/6L	1041.07							L	12	6	
	TN98R-12/8L	1041.08							L	12	8	
	TN98R-15/10L	1041.10							L	15	10	
	TN98R-15/12L	1041.11							L	15	12	
	TN98R-18/10L	1041.12							L	18	10	
	TN98R-18/12L	1041.13							L	18	12	
	TN98R-18/15L	1041.14							L	18	15	
	TN98R-22/12L	1041.15							L	22	12	
	TN98R-22/15L	1041.16							L	22	15	
	TN98R-22/18L	1041.17							L	22	18	
	TN98R-28/18L	1041.18							L	28	18	
	TN98R-28/22L	1041.19							L	28	22	
	TN98R-35/22L	1041.20							L	35	22	
	TN98R-35/28L	1041.21							L	35	28	
	TN98R-8/6L	1041.04							L	8	6	
	TN98R-10/6S	1041.23							S	10	6	
	TN98R-10/8S	1041.24							S	10	8	
	TN98R-12/10S	1041.27							S	12	10	
	TN98R-12/6S	1041.25							S	12	6	
	TN98R-12/8S	1041.26							S	12	8	
	TN98R-14/10S	1041.28							S	14	10	
	TN98R-14/12S	1041.29							S	14	12	
	TN98R-16/12S	1041.30							S	16	12	
	TN98R-16/14S	1041.31							S	16	14	
	TN98R-20/10S	1041.32							S	20	10	
TN98R-20/12S	1041.33							S	20	12		
TN98R-20/14S	1041.							S	20	14		
TN98R-20/16S	1041.34							S	20	16		
TN98R-25/16S	1041.35							S	25	16		
TN98R-25/20S	1041.36							S	25	20		
TN98R-30/20S	1041.37							S	30	20		
TN98R-30/25S	1041.38							S	30	25		
TN98R-38/25S	1041.							S	38	25		
TN98R-38/30S	1041.39							S	38	30		
TN98R-8/6S	1041.22							S	8	6		

**RACCORDO ORIENTABILE A GOMITO
 ANGULAR ROTARY FITTING
 RACOR EN CODO REGULABLE
 EINSTELLBARE WINKEL-ANSCHLUSSSTUTZEN**

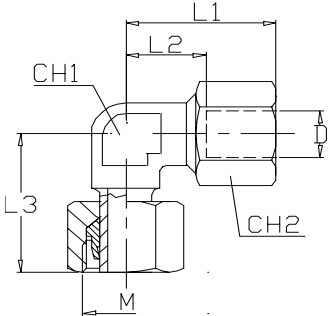
TN119	CODICE 1	CODICE 2	L1	L2	L3	L4	CH1	CH2	SERIE	TUBO	DADO	M	
	TN119-6L	1042.04							L	6	12X1,5		
	TN119-8L	1042.05							L	8	14X1,5		
	TN119-10L	1042.06							L	10	16X1,5		
	TN119-12L	1042.07							L	12	18X1,5		
	TN119-15L	1042.08							L	15	22X1,5		
	TN119-18L	1042.09							L	18	26X1,5		
	TN119-22L	1042.10							L	22	30X2		
	TN119-28L	1042.11							L	28	36X2		
	TN119-35L	1042.12							L	35	45X2		
	TN119-42L	1042.13							L	42	52X2		
	TN119-6S	1042.14								S	6	14X1,5	
	TN119-8S	1042.15								S	8	16X1,5	
	TN119-10S	1042.16								S	10	18X1,5	
	TN119-12S	1042.17								S	12	20X1,5	
	TN119-14S	1042.18								S	14	22X1,5	
	TN119-16S	1042.19								S	16	24X1,5	
	TN119-20S	1042.20								S	20	30X2	
	TN119-25S	1042.21								S	25	36X2	
	TN119-30S	1042.22								S	30	42X2	
	TN119-38S	1042.23								S	38	52X2	

RACCORDO A TEE ORIENTABILE AL CENTRO
ROTARY T-FITTING
RACOR EN "T" REGULABLE
EINSTELLBARE T-ANSCHLUSSSTUTZEN

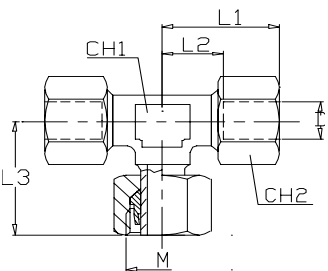
TN120	CODICE 1	CODICE 2	L1	L2	L3	L4	CH1	CH2	SERIE	TUBO	DADO	M
	TN120-6L	1050.04							L	6	12X1,5	
	TN120-8L	1050.05							L	8	14X1,5	
	TN120-10L	1050.06							L	10	16X1,5	
	TN120-12L	1050.07							L	12	18X1,5	
	TN120-15L	1050.08							L	15	22X1,5	
	TN120-18L	1050.09							L	18	26X1,5	
	TN120-22L	1050.10							L	22	30X2	
	TN120-28L	1050.11							L	28	36X2	
	TN120-35L	1050.12							L	35	45X2	
	TN120-42L	1050.13							L	42	52X2	
	TN120-6S	1050.14							S	6	14X1,5	
	TN120-8S	1050.15							S	8	16X1,5	
	TN120-10S	1050.16							S	10	18X1,5	
	TN120-12S	1050.17							S	12	20X1,5	
	TN120-14S	1050.18							S	14	22X1,5	
	TN120-16S	1050.19							S	16	24X1,5	
	TN120-20S	1050.20							S	20	30X2	
	TN120-25S	1050.21							S	25	36X2	
	TN120-30S	1050.22							S	30	42X2	
	TN120-38S	1050.23							S	38	52X2	

RACCORDO A TEE ORIENTABILE A LATO
ROTARY L-FITTING
RACOR EN "T" REGULABLE
EINSTELLBARE L-ANSCHLUSSSTUTZEN

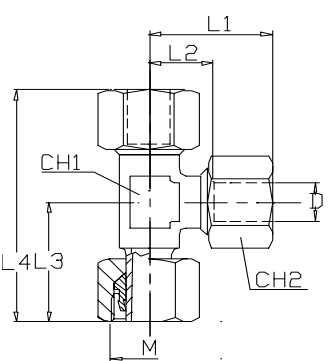
TN121	CODICE 1	CODICE 2	L1	L2	L3	L4	CH1	CH2	SERIE	TUBO	DADO	M
	TN121-6L	1046.04							L	6	12X1,5	
	TN121-8L	1046.05							L	8	14X1,5	
	TN121-10L	1046.06							L	10	16X1,5	
	TN121-12L	1046.07							L	12	18X1,5	
	TN121-15L	1046.08							L	15	22X1,5	
	TN121-18L	1046.09							L	18	26X1,5	
	TN121-22L	1046.10							L	22	30X2	
	TN121-28L	1046.11							L	28	36X2	
	TN121-35L	1046.12							L	35	45X2	
	TN121-42L	1046.13							L	42	52X2	
	TN121-6S	1046.14							S	6	14X1,5	
	TN121-8S	1046.15							S	8	16X1,5	
	TN121-10S	1046.16							S	10	18X1,5	
	TN121-12S	1046.17							S	12	20X1,5	
	TN121-14S	1046.18							S	14	22X1,5	
	TN121-16S	1046.19							S	16	24X1,5	
	TN121-20S	1046.20							S	20	30X2	
	TN121-25S	1046.21							S	25	36X2	
	TN121-30S	1046.22							S	30	42X2	
	TN121-38S	1046.23							S	38	52X2	

RACCORDO DI RIDUZIONE SEMPLICE
STANDPIPE/TUBE REDUCERS
RACOR DE REDUCCION
REDUZIEREINSATZE

TN132	CODICE 1	CODICE 2	L1	L2	L3	L4	CH1	CH2	SERIE	TUBO	DADO	M
	TN132-10/6L	1053.02.1							L			10/6 -
	TN132-10/8L	1053.10.1							L			10/8 -
	TN132-12/10L	1053.18.1							L			12/10 -
	TN132-12/6L	1053.03.1							L			12/6 -
	TN132-12/8L	1053.11.1							L			12/8 -
	TN132-15/10L	1053.19.1							L			15/10 -
	TN132-15/12L	1053.25.1							L			15/12 -
	TN132-15/6L	1053.04.1							L			15/6 -
	TN132-15/8L	1053.12.1							L			15/8 -
	TN132-18/10L	1053.20.1							L			18/10 -
	TN132-18/12L	1053.26.1							L			18/12 -
	TN132-18/15L	1053.31.1							L			18/15 -
	TN132-18/6L	1053.05.1							L			18/6 -
	TN132-18/8L	1053.13.1							L			18/8 -
	TN132-22/10L	1053.21.1							L			22/10 -
	TN132-22/12L	1053.27.1							L			22/12 -
	TN132-22/15L	1053.32.1							L			22/15 -
	TN132-22/18L	1053.36.1							L			22/18 -
	TN132-22/6L	1053.06.1							L			22/6 -
	TN132-22/8L	1053.14.1							L			22/8 -
	TN132-28/10L	1053.22.1							L			28/10 -
	TN132-28/12L	1053.28.1							L			28/12 -
	TN132-28/15L	1053.33.1							L			28/15 -
	TN132-28/18L	1053.37.1							L			28/18 -
	TN132-28/22L	1053.40.1							L			28/22 -
	TN132-28/6L	1053.07.1							L			28/6 -
	TN132-28/8L	1053.15.1							L			28/8 -
	TN132-35/10L	1053.23.1							L			35/10 -
	TN132-35/12L	1053.29.1							L			35/12 -
	TN132-35/15L	1053.34.1							L			35/15 -
	TN132-35/18L	1053.38.1							L			35/18 -
	TN132-35/22L	1053.41.1							L			35/22 -
	TN132-35/28L	1053.43.1							L			35/28 -
	TN132-35/6L	1053.08.1							L			35/6 -
	TN132-35/8L	1053.16.1							L			35/8 -
	TN132-42/10L	1053.24.1							L			42/10 -
	TN132-42/12L	1053.30.1							L			42/12 -
	TN132-42/15L	1053.35.1							L			42/15 -
	TN132-42/18L	1053.39.1							L			42/18 -
	TN132-42/22L	1053.42.1							L			42/22 -
	TN132-42/28L	1053.44.1							L			42/28 -
	TN132-42/35L	1053.45.1							L			42/35 -
	TN132-42/6L	1053.09.1							L			42/6 -
	TN132-42/8L	1053.17.1							L			42/8 -
	TN132-8/6L	1053.01.1							L			8/6 -

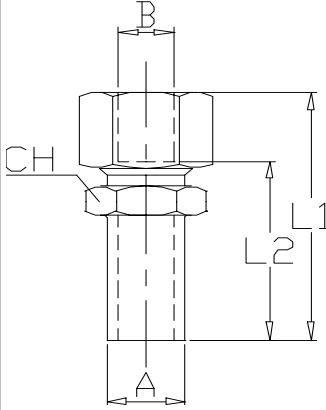

**RACCORDO DI RIDUZIONE SEMPLICE
 STANDPIPE/TUBE REDUCERS
 RACOR DE REDUCCION
 REDUZIEREINSATZE**

TN132	CODICE 1	CODICE 2	L1	L2	L3	L4	CH1	CH2	SERIE	TUBO	DADO	M
	TN132-10/6S	1054.02.1							S			10/6 -
	TN132-10/8S	1054.10.1							S			10/8 -
	TN132-12/10S	1054.18.1							S			12/10 -
	TN132-12/6S	1054.03.1							S			12/6 -
	TN132-12/8S	1054.11.1							S			12/8 -
	TN132-14/10S	1054.19.1							S			14/10 -
	TN132-14/12S	1054.25.1							S			14/12 -
	TN132-14/6S	1054.04.1							S			14/6 -
	TN132-14/8S	1054.12.1							S			14/8 -
	TN132-16/10S	1054.20.1							S			16/10 -
	TN132-16/12S	1054.26.1							S			16/12 -
	TN132-16/14S	1054.31.1							S			16/14 -
	TN132-16/6S	1054.05.1							S			16/6 -
	TN132-16/8S	1054.13.1							S			16/8 -
	TN132-20/10S	1054.21.1							S			20/10 -
	TN132-20/12S	1054.27.1							S			20/12 -
	TN132-20/14S	1054.32.1							S			20/14 -
	TN132-20/16S	1054.36.1							S			20/16 -
	TN132-20/6S	1054.06.1							S			20/6 -
	TN132-20/8S	1054.14.1							S			20/8 -
	TN132-25/10S	1054.22.1							S			25/10 -
	TN132-25/12S	1054.28.1							S			25/12 -
	TN132-25/14S	1054.33.1							S			25/14 -
	TN132-25/16S	1054.37.1							S			25/16 -
	TN132-25/20S	1054.40.1							S			25/20 -
	TN132-25/6S	1054.07.1							S			25/6 -
	TN132-25/8S	1054.15.1							S			25/8 -
	TN132-30/10S	1054.23.1							S			30/10 -
	TN132-30/12S	1054.29.1							S			30/12 -
	TN132-30/14S	1054.34.1							S			30/14 -
	TN132-30/16S	1054.38.1							S			30/16 -
	TN132-30/20S	1054.41.1							S			30/20 -
	TN132-30/25S	1054.43.1							S			30/25 -
	TN132-30/6S	1054.08.1							S			30/6 -
	TN132-30/8S	1054.16.1							S			30/8 -
	TN132-38/10S	1054.24.1							S			38/10 -
	TN132-38/12S	1054.30.1							S			38/12 -
	TN132-38/14S	1054.35.1							S			38/14 -
	TN132-38/16S	1054.39.1							S			38/16 -
	TN132-38/20S	1054.42.1							S			38/20 -
	TN132-38/25S	1054.44.1							S			38/25 -
	TN132-38/30S	1054.45.1							S			38/30 -
	TN132-38/6S	1054.09.1							S			38/6 -
	TN132-38/8S	1054.17.1							S			38/8 -
	TN132-8/6S	1054.01.1							S			8/6 -

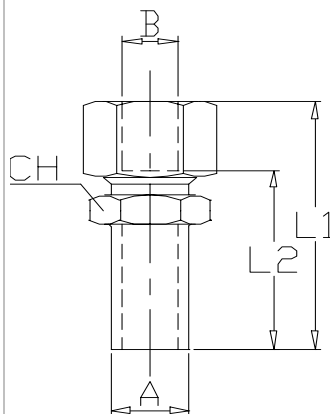

**RACCORDO DI RIDUZIONE SEMPLICE PREMONTATO
 STANDPIPE/TUBE REDUCERS
 RACOR DE REDUCCION CON TUERCA Y ANILLO
 REDUZIEREINSATZE**

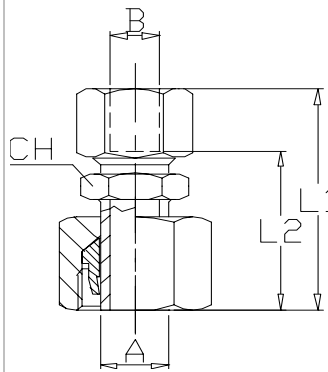
TN132A	CODICE 1	CODICE 2	L1	L2	L3	L4	CH1	CH2	SERIE	TUBO	DADO	M
	TN132A-10/6L	1053.02							L			10/6 -
	TN132A-10/8L	1053.10							L			10/8 -
	TN132A-12/10L	1053.18							L			12/10 -
	TN132A-12/6L	1053.03							L			12/6 -
	TN132A-12/8L	1053.11							L			12/8 -
	TN132A-15/10L	1053.19							L			15/10 -
	TN132A-15/12L	1053.25							L			15/12 -
	TN132A-15/6L	1053.04							L			15/6 -
	TN132A-15/8L	1053.12							L			15/8 -
	TN132A-18/10L	1053.20							L			18/10 -
	TN132A-18/12L	1053.26							L			18/12 -
	TN132A-18/15L	1053.31							L			18/15 -
	TN132A-18/6L	1053.05							L			18/6 -
	TN132A-18/8L	1053.13							L			18/8 -
	TN132A-22/10L	1053.21							L			22/10 -
	TN132A-22/12L	1053.27							L			22/12 -
	TN132A-22/15L	1053.32							L			22/15 -
	TN132A-22/18L	1053.36							L			22/18 -
	TN132A-22/6L	1053.06							L			22/6 -
	TN132A-22/8L	1053.14							L			22/8 -
	TN132A-28/10L	1053.22							L			28/10 -
	TN132A-28/12L	1053.28							L			28/12 -
	TN132A-28/15L	1053.33							L			28/15 -
	TN132A-28/18L	1053.37							L			28/18 -
	TN132A-28/22L	1053.40							L			28/22 -
	TN132A-28/6L	1053.07							L			28/6 -
	TN132A-28/8L	1053.15							L			28/8 -
	TN132A-35/10L	1053.23							L			35/10 -
	TN132A-35/12L	1053.29							L			35/12 -
	TN132A-35/15L	1053.34							L			35/15 -
	TN132A-35/18L	1053.38							L			35/18 -
	TN132A-35/22L	1053.41							L			35/22 -
	TN132A-35/28L	1053.43							L			35/28 -
	TN132A-35/6L	1053.08							L			35/6 -
	TN132A-35/8L	1053.16							L			35/8 -
	TN132A-42/10L	1053.24							L			42/10 -
TN132A-42/12L	1053.30							L			42/12 -	
TN132A-42/15L	1053.35							L			42/15 -	
TN132A-42/18L	1053.39							L			42/18 -	
TN132A-42/22L	1053.42							L			42/22 -	
TN132A-42/28L	1053.44							L			42/28 -	
TN132A-42/35L	1053.45							L			42/35 -	
TN132A-42/6L	1053.09							L			42/6 -	
TN132A-42/8L	1053.17							L			42/8 -	
TN132A-8/6L	1053.01							L			8/6 -	

RACCORDO DI RIDUZIONE SEMPLICE PREMONTATO
STANDPIPE/TUBE REDUCERS
RACOR DE REDUCCION CON TUERCA Y ANILLO
REDUZIEREINSATZE

TN132A	CODICE 1	CODICE 2	L1	L2	L3	L4	CH1	CH2	SERIE	TUBO	DADO	M
	TN132A-10/6S	1054.02							S			10/6 -
	TN132A-10/8S	1054.10							S			10/8 -
	TN132A-12/10S	1054.18							S			12/10 -
	TN132A-12/6S	1054.03							S			12/6 -
	TN132A-12/8S	1054.11							S			12/8 -
	TN132A-14/10S	1054.19							S			14/10 -
	TN132A-14/12S	1054.25							S			14/12 -
	TN132A-14/6S	1054.04							S			14/6 -
	TN132A-14/8S	1054.12							S			14/8 -
	TN132A-16/10S	1054.20							S			16/10 -
	TN132A-16/12S	1054.26							S			16/12 -
	TN132A-16/14S	1054.31							S			16/14 -
	TN132A-16/6S	1054.05							S			16/6 -
	TN132A-16/8S	1054.13							S			16/8 -
	TN132A-20/10S	1054.21							S			20/10 -
	TN132A-20/12S	1054.27							S			20/12 -
	TN132A-20/14S	1054.32							S			20/14 -
	TN132A-20/16S	1054.36							S			20/16 -
	TN132A-20/6S	1054.06							S			20/6 -
	TN132A-20/8S	1054.14							S			20/8 -
	TN132A-25/10S	1054.22							S			25/10 -
	TN132A-25/12S	1054.28							S			25/12 -
	TN132A-25/14S	1054.33							S			25/14 -
	TN132A-25/16S	1054.37							S			25/16 -
	TN132A-25/20S	1054.40							S			25/20 -
	TN132A-25/6S	1054.07							S			25/6 -
	TN132A-25/8S	1054.15							S			25/8 -
	TN132A-30/10S	1054.23							S			30/10 -
	TN132A-30/12S	1054.29							S			30/12 -
	TN132A-30/14S	1054.34							S			30/14 -
	TN132A-30/16S	1054.38							S			30/16 -
	TN132A-30/20S	1054.41							S			30/20 -
	TN132A-30/25S	1054.43							S			30/25 -
	TN132A-30/6S	1054.08							S			30/6 -
	TN132A-30/8S	1054.16							S			30/8 -
	TN132A-38/10S	1054.24							S			38/10 -
	TN132A-38/12S	1054.30							S			38/12 -
	TN132A-38/14S	1054.35							S			38/14 -
	TN132A-38/16S	1054.39							S			38/16 -
	TN132A-38/20S	1054.42							S			38/20 -
	TN132A-38/25S	1054.44							S			38/25 -
	TN132A-38/30S	1054.45							S			38/30 -
	TN132A-38/6S	1054.09							S			38/6 -
	TN132A-38/8S	1054.17							S			38/8 -
	TN132A-8/6S	1054.01							S			8/6 -

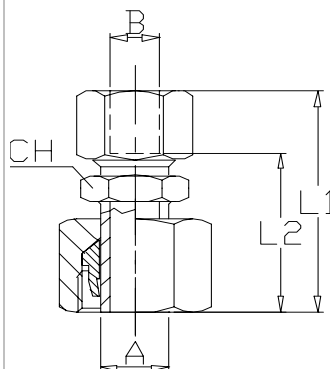

RACCORDO COMBINATO ORIENTABILE A GOMITO
SWIVEL ELBOWS
RACOR EN "L" TUBO - ROSCA CILINDRICA ORIENTABLE
EINSTELLBARE WINKEL-VERSCHRAUBUNGEN

TN114	CODICE 1	CODICE 2	L1	L2	L3	L4	CH1	CH2	SERIE	TUBO	DADO	M	
	TN114-6LR	1043.04							LR	6		1/8	
	TN114-8LR	1043.05							LR	8		1/4	
	TN114-10LR	1043.06							LR	10		1/4	
	TN114-12LR	1043.07							LR	12		3/8	
	TN114-15LR	1043.08							LR	15		1/2	
	TN114-18LR	1043.09							LR	18		1/2	
	TN114-22LR	1043.10							LR	22		3/4	
	TN114-28LR	1043.11							LR	28		1"	
	TN114-35LR	1043.12							LR	35		1.1/4	
	TN114-42LR	1043.13							LR	42		1.1/2	
	TN114-6SR	1043.14								SR	6		1/4
	TN114-8SR	1043.15								SR	8		1/4
	TN114-10SR	1043.16								SR	10		3/8
TN114-12SR	1043.17								SR	12		3/8	
TN114-14SR	1043.18								SR	14		1/2	
TN114-16SR	1043.19								SR	16		1/2	
TN114-20SR	1043.20								SR	20		3/4	
TN114-25SR	1043.21								SR	25		1"	
TN114-30SR	1043.22								SR	30		1.1/4	
TN114-38SR	1043.23								SR	38		1.1/2	
TN114-6LM	1044.04								LM	6		10X1	
TN114-8LM	1044.05								LM	8		12X1,5	
TN114-10LM	1044.06								LM	10		14X1,5	
TN114-12LM	1044.07								LM	12		16X1,5	
TN114-15LM	1044.08								LM	15		18X1,5	
TN114-18LM	1044.09								LM	18		22X1,5	
TN114-22LM	1044.10								LM	22		26X1,5	
TN114-28LM	1044.11								LM	28		33X2	
TN114-35LM	1044.12								LM	35		42X2	
TN114-42LM	1044.13								LM	42		48X2	
TN114-6SM	1044.14								SM	6		12X1,5	
TN114-8SM	1044.15								SM	8		14X1,5	
TN114-10SM	1044.16								SM	10		16X1,5	
TN114-12SM	1044.17								SM	12		18X1,5	
TN114-14SM	1044.18								SM	14		20X1,5	
TN114-16SM	1044.19								SM	16		22X1,5	
TN114-20SM	1044.20								SM	20		27X2	
TN114-25SM	1044.21								SM	25		33X2	
TN114-30SM	1044.22								SM	30		42X2	
TN114-38SM	1044.23								SM	38		48X2	

RACCORDO COMBINATO ORIENTABILE A TEE
SWIVEL BRANCH TEES
RACOR EN "T" TUBO - ROSCA CILINDRICA ORIENTABLE - TUBO
EINSTELLBARE T-VERSCHRAUBUNGEN

TN115	CODICE 1	CODICE 2	L1	L2	L3	L4	CH1	CH2	SERIE	TUBO	DADO	M	
	TN115-6LR	1051.04							LR	6		1/8	
	TN115-8LR	1051.05							LR	8		1/4	
	TN115-10LR	1051.06							LR	10		1/4	
	TN115-12LR	1051.07							LR	12		3/8	
	TN115-15LR	1051.08							LR	15		1/2	
	TN115-18LR	1051.09							LR	18		1/2	
	TN115-22LR	1051.10							LR	22		3/4	
	TN115-28LR	1051.11							LR	28		1"	
	TN115-35LR	1051.12							LR	35		1.1/4	
	TN115-42LR	1051.13							LR	42		1.1/2	
	TN115-6SR	1051.14								SR	6		1/4
	TN115-8SR	1051.15								SR	8		1/4
	TN115-10SR	1051.16								SR	10		3/8
TN115-12SR	1051.17								SR	12		3/8	
TN115-14SR	1051.18								SR	14		1/2	
TN115-16SR	1051.19								SR	16		1/2	
TN115-20SR	1051.20								SR	20		3/4	
TN115-25SR	1051.21								SR	25		1"	
TN115-30SR	1051.22								SR	30		1.1/4	
TN115-38SR	1051.23								SR	38		1.1/2	
TN115-6LM	1052.04								LM	6		10X1	
TN115-8LM	1052.05								LM	8		12X1,5	
TN115-10LM	1052.06								LM	10		14X1,5	
TN115-12LM	1052.07								LM	12		16X1,5	
TN115-15LM	1052.08								LM	15		18X1,5	
TN115-18LM	1052.09								LM	18		22X1,5	
TN115-22LM	1052.10								LM	22		26X1,5	
TN115-28LM	1052.11								LM	28		33X2	
TN115-35LM	1052.12								LM	35		42X2	
TN115-42LM	1052.13								LM	42		48X2	
TN115-6SM	1052.14								SM	6		12X1,5	
TN115-8SM	1052.15								SM	8		14X1,5	
TN115-10SM	1052.16								SM	10		16X1,5	
TN115-12SM	1052.17								SM	12		18X1,5	
TN115-14SM	1052.18								SM	14		20X1,5	
TN115-16SM	1052.19								SM	16		22X1,5	
TN115-20SM	1052.20								SM	20		27X2	
TN115-25SM	1052.21								SM	25		33X2	
TN115-30SM	1052.22								SM	30		42X2	
TN115-38SM	1052.23								SM	38		48X2	

RACCORDO COMBINATO ORIENTABILE A L
SWIVEL BARREL TEES
RACOR EN "T" TUBO - TUBO - ROSCA CILINDRICA ORIENTABLE
EINSTELLBARE L-VERSCHRAUBUNGEN

TN116	CODICE 1	CODICE 2	L1	L2	L3	L4	CH1	CH2	SERIE	TUBO	DADO	M	
	TN116-6LR	1047.04							LR	6		1/8	
	TN116-8LR	1047.05							LR	8		1/4	
	TN116-10LR	1047.06							LR	10		1/4	
	TN116-12LR	1047.07							LR	12		3/8	
	TN116-15LR	1047.08							LR	15		1/2	
	TN116-18LR	1047.09							LR	18		1/2	
	TN116-22LR	1047.10							LR	22		3/4	
	TN116-28LR	1047.11							LR	28		1"	
	TN116-35LR	1047.12							LR	35		1.1/4	
	TN116-42LR	1047.13							LR	42		1.1/2	
	TN116-6SR	1047.14								SR	6		1/4
	TN116-8SR	1047.15								SR	8		1/4
	TN116-10SR	1047.16								SR	10		3/8
	TN116-12SR	1047.17								SR	12		3/8
	TN116-14SR	1047.18								SR	14		1/2
	TN116-16SR	1047.19								SR	16		1/2
	TN116-20SR	1047.20								SR	20		3/4
	TN116-25SR	1047.21								SR	25		1"
	TN116-30SR	1047.22								SR	30		1.1/4
	TN116-38SR	1047.23								SR	38		1.1/2
	TN116-6LM	1048.04								LM	6		10X1
	TN116-8LM	1048.05								LM	8		12X1,5
	TN116-10LM	1048.06								LM	10		14X1,5
	TN116-12LM	1048.07								LM	12		16X1,5
	TN116-15LM	1048.08								LM	15		18X1,5
	TN116-18LM	1048.09								LM	18		22X1,5
	TN116-22LM	1048.10								LM	22		26X1,5
	TN116-28LM	1048.11								LM	28		33X2
	TN116-35LM	1048.12								LM	35		42X2
	TN116-42LM	1048.13								LM	42		48X2
	TN116-6SM	1048.14								SM	6		12X1,5
	TN116-8SM	1048.15								SM	8		14X1,5
	TN116-10SM	1048.16								SM	10		16X1,5
	TN116-12SM	1048.17								SM	12		18X1,5
	TN116-14SM	1048.18								SM	14		20X1,5
	TN116-16SM	1048.19								SM	16		22X1,5
	TN116-20SM	1048.20								SM	20		27X2
	TN116-25SM	1048.21								SM	25		33X2
TN116-30SM	1048.22								SM	30		42X2	
TN116-38SM	1048.23								SM	38		48X2	

RACCORDO DI ESTREMITA DIRITTO FILETTO CILINDRICO
MALE STUD COUPLINGS
RACOR RECTO ROSCA CILINDRICA
GERADE EINSCHRAUBVERSCHRAUBUNGEN

TN92	CODICE 1	CODICE 2	L1	L2	L3	L4	CH1	CH2	SERIE	TUBO	DADO	M	
	TN92-4LLR	1003.01							LLR	4		1/8	
	TN92-6LLR	1003.02							LLR	6		1/8	
	TN92-8LLR	1003.03							LLR	8		1/8	
	TN92-6LR	1003.04							LR	6		1/8	
	TN92-6LR 1/4	1003.24							LR	6		1/4	
	TN92-8LR	1003.05							LR	8		1/4	
	TN92-8LR 1/8	1003.25							LR	8		1/8	
	TN92-8LR 3/8	1003.26							LR	8		3/8	
	TN92-8LR 1/2	1003.27							LR	8		1/2	
	TN92-10LR	1003.06							LR	10		1/4	
	TN92-10LR 1/2	1003.30							LR	10		1/2	
	TN92-10LR 1/8	1003.28							LR	10		1/8	
	TN92-10LR 3/8	1003.29							LR	10		3/8	
	TN92-12LR	1003.07							LR	12		3/8	
	TN92-12LR 1/2	1003.32							LR	12		1/2	
	TN92-12LR 1/4	1003.31							LR	12		1/4	
	TN92-15LR	1003.08							LR	15		1/2	
	TN92-15LR 3/8	1003.33							LR	15		3/8	
	TN92-18LR	1003.09							LR	18		1/2	
	TN92-18LR 3/4	1003.34							LR	18		3/4	
	TN92-22LR	1003.10							LR	22		3/4	
	TN92-28LR	1003.11							LR	28		1"	
	TN92-35LR	1003.12							LR	35		1.1/4	
	TN92-42LR	1003.13							LR	42		1.1/2	
	TN92-6SR	1003.14								SR	6		1/4
	TN92-8SR	1003.15								SR	8		1/4
	TN92-10SR	1003.16								SR	10		3/8
	TN92-10SR 1/4	1003.42								SR	10		1/4
	TN92-12SR	1003.17								SR	12		3/8
	TN92-12SR 1/2	1003.35								SR	12		1/2
	TN92-12SR 1/4	1003.44								SR	12		1/4
	TN92-14SR	1003.18								SR	14		1/2
	TN92-14SR 3/8	1003.36								SR	14		3/8
	TN92-16SR	1003.19								SR	16		1/2
	TN92-16SR 3/4	1003.45								SR	16		3/4
	TN92-16SR 3/8	1003.37								SR	16		3/8
	TN92-20SR	1003.20								SR	20		3/4
	TN92-20SR 1"	1003.46								SR	20		1"
	TN92-20SR 1/2	1003.38								SR	20		1/2
	TN92-25SR	1003.21								SR	25		1"
TN92-25SR 3/4	1003.39								SR	25		3/4	
TN92-30SR	1003.22								SR	30		1.1/4	
TN92-30SR 1"	1003.40								SR	30		1"	
TN92-38SR	1003.23								SR	38		1.1/2	

RACCORDO DI ESTREMITA DIRITTO FILETTO CILINDRICO
MALE STUD COUPLINGS
RACOR RECTO ROSCA CILINDRICA
GERADE EINSCHRAUBVERSCHRAUBUNGEN

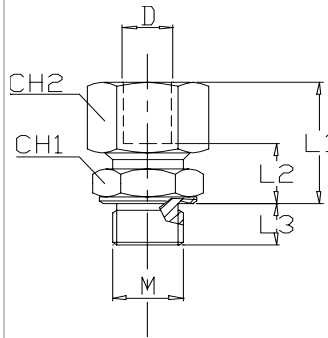

TN92	CODICE 1	CODICE 2	L1	L2	L3	L4	CH1	CH2	SERIE	TUBO	DADO	M
	TN92-4LLM	1004.01							LLM	4		8X1
	TN92-6LLM	1004.02							LLM	6		10X1
	TN92-8LLM	1004.03							LLM	8		10X1
	TN92-6LM	1004.04							LM	6		10X1
	TN92-8LM	1004.05							LM	8		12X1,5
	TN92-10LM	1004.06							LM	10		14X1,5
	TN92-12LM	1004.07							LM	12		16X1,5
	TN92-12LM 14A	1004.29							LM	12		14X1,5
	TN92-12LM 18A	1004.30							LM	12		18X1,5
	TN92-12LM 22A	1004.31							LM	12		22X1,5
	TN92-15LM	1004.08							LM	15		18X1,5
	TN92-15LM 16A	1004.32							LM	15		16X1,5
	TN92-15LM 22A	1004.33							LM	15		22X1,5
	TN92-18LM	1004.09							LM	18		22X1,5
	TN92-22LM	1004.10							LM	22		26X1,5
	TN92-28LM	1004.11							LM	28		33X2
	TN92-35LM	1004.12							LM	35		42X2
	TN92-42LM	1004.13							LM	42		48X2
	TN92-6SM	1004.14							SM	6		12X1,5
	TN92-8SM	1004.15							SM	8		14X1,5
	TN92-10SM	1004.16							SM	10		16X1,5
	TN92-12SM	1004.17							SM	12		18X1,5
	TN92-14SM	1004.18							SM	14		20X1,5
	TN92-16SM	1004.19							SM	16		22X1,5
	TN92-20SM	1004.20							SM	20		27X2
	TN92-25SM	1004.21							SM	25		33X2
	TN92-30SM	1004.22							SM	30		42X2
	TN92-38SM	1004.23							SM	38		48X2

RACCORDO DI ESTREMITA DIRITTO FILETTO CILINDRICO CON GUARNIZIONE
MALE STUD COUPLINGS RUBBER SEAL
RACOR RECTO CO JUNTA TORICA ROSCA CILINDRICA
GERADE EINSCHRAUBVERSCHRAUBUNGEN

TN92GG	CODICE 1	CODICE 2	L1	L2	L3	L4	CH1	CH2	SERIE	TUBO	DADO	M	
	TN92GG-6LR	1005.04							LR	6		1/8	
	TN92GG-6LR 1/4	1005.24							LR	6		1/4	
	TN92GG-8LR 1/4	1005.05							LR	8		1/4	
	TN92GG-10LR	1005.06							LR	10		1/4	
	TN92GG-12LR	1005.07							LR	12		3/8	
	TN92GG-12LR1/2	1005.32							LR	12		1/2	
	TN92GG-15LR	1005.08							LR	15		1/2	
	TN92GG-18LR3/4	1005.34							LR	16		3/4	
	TN92GG-18LR	1005.09							LR	18		1/2	
	TN92GG-22LR	1005.10							LR	22		3/4	
	TN92GG-8SR	1005.15								SR	8	1/4	
	TN92GG-10SR	1005.16								SR	10	3/8	
	TN92GG-10SR1/2	1005.43								SR	10	1/2	
	TN92GG-10SR1/4	1005.42								SR	10	1/4	
	TN92GG-12SR	1005.17								SR	12	3/8	
	TN92GG-12SR1/2									SR	12	1/2	
	TN92GG-12SR1/4	1005.44								SR	12	1/4	
	TN92GG-14SR	1005.18								SR	14	1/2	
	TN92GG-16SR	1005.19								SR	16	1/2	
	TN92GG-16SR3/4	1005.45								SR	16	3/4	
	TN92GG-20SR	1005.20								SR	20	3/4	
	TN92GG-25SR	1005.21								SR	25	1"	
	TN92GG-30SR	1005.22								SR	30	1.1/4	
	TN92GG-38SR	1005.23								SR	38	1.1/2	
	TN92GG-6LM	1006.04									LM	6	10X1
	TN92GG-8LM	1006.05									LM	8	12X1,5
	TN92GG-6SM	1006.14									SM	6	12X1,5
	TN92GG-8SM	1006.15									SM	8	14X1,5
TN92GG-12SM	1006.17									SM	12	18X1,5	
TN92GG-16SM	1006.19									SM	16	22X1,5	

RACCORDO DI ESTREMITA DIRITTO FILETTO CONICO
MALE STUD COUPLINGS
RACOR RECTO ROSCA CONICA
GERADE EINSCHRAUBVERSCHRAUBUNGEN

TN93	CODICE 1	CODICE 2	L1	L2	L3	L4	CH1	CH2	SERIE	TUBO	DADO	M
	TN93-4LLR	1017.01							LLR	4		1/8
	TN93-5LLR	1017.-							LLR	5		1/8
	TN93-6LLR	1017.02							LLR	6		1/8
	TN93-8LLR	1017.03							LLR	8		1/8
	TN93-8LLR 1/4	1017.-							LLR	8		1/4
	TN93-10LLR	1017.-							LLR	10		
	TN93-12LLR	1017.-							LLR	12		1/4
	TN93-12LLR 3/8	1017.-							LLR	12		3/8
	TN93-15LLR	1017.-							LLR	15		
	TN93-15LLR 1/2	1017.-							LLR	15		1/2
	TN93-18LLR	1017.-							LLR	18		
	TN93-22LLR	1017.10							LLR	22		
	TN93-6LR	1017.04							LR	6		1/8
	TN93-6LR 1/4	1017.24							LR	6		1/4
	TN93-8LR	1017.05							LR	8		1/4
	TN93-8LR 3/8	1017.26							LR	8		3/8
	TN93-10LR	1017.06							LR	10		1/4
	TN93-10LR 3/8	1017.29							LR	10		3/8
	TN93-12LR	1017.07							LR	12		3/8
	TN93-12LR 1/2	1017.32							LR	12		1/2
	TN93-12LR 1/4	1017.31							LR	12		1/4
	TN93-15LR	1017.08							LR	15		1/2
TN93-15LR 3/8	1017.33							LR	15		3/8	
TN93-18LR	1017.09							LR	18		1/2	
TN93-22LR	1017.10							LR	22		3/4	
TN93-28LR	1017.11							LR	28		1"	
TN93-35LR	1017.12							LR	35		1.1/4	
TN93-42LR	1017.13							LR	42		1.1/2	
TN93-6SR	1017.14							SR	6		1/4	
TN93-8SR	1017.15							SR	8		1/4	
TN93-10SR	1017.16							SR	10		3/8	
TN93-12SR	1017.17							SR	12		3/8	
TN93-12SR 1/2	1017.35							SR	12		1/2	
TN93-14SR	1017.18							SR	14		1/2	
TN93-16SR	1017.19							SR	16		1/2	
TN93-16SR 3/8	1017.37							SR	16		3/8	
TN93-20SR	1017.20							SR	20		3/4	
TN93-25SR	1017.21							SR	25		1"	
TN93-30SR	1017.22							SR	30		1.1/4	
TN93-38SR	1017.23							SR	38		1.1/2	

RACCORDO DI ESTREMITA DIRITTO FILETTO CONICO
MALE STUD COUPLINGS
RACOR RECTO ROSCA CONICA
GERADE EINSCHRAUBVERSCHRAUBUNGEN

TN93	CODICE 1	CODICE 2	L1	L2	L3	L4	CH1	CH2	SERIE	TUBO	DADO	M	
	TN93-4LLM	1019.01							LLM	4		8X1	
	TN93-5LLM	1019.-							LLM	5		8X1	
	TN93-6LLM	1019.02							LLM	6		10X1	
	TN93-8LLM	1019.03							LLM	8		10X1	
	TN93-6LM	1019.04							LM	6		10X1	
	TN93-8LM	1019.05							LM	8		12X1,5	
	TN93-10LM	1019.06							LM	10		14X1,5	
	TN93-12LM	1019.07							LM	12		16X1,5	
	TN93-15LM	1019.08							LM	15		18X1,5	
	TN93-18LM	1019.09							LM	18		22X1,5	
	TN93-22LM	1019.10							LM	22		26X1,5	
	TN93-28LM	1019.11							LM	28		33X2	
	TN93-35LM	1019.12							LM	35		42X2	
	TN93-42LM	1019.13							LM	42		48X2	
	TN93-6SM	1019.14								SM	6		12X1,5
	TN93-8SM	1019.15								SM	8		14X1,5
	TN93-10SM	1019.16								SM	10		16X1,5
	TN93-12SM	1019.17								SM	12		18X1,5
	TN93-14SM	1019.18								SM	14		20X1,5
	TN93-16SM	1019.19								SM	16		22X1,5
	TN93-20SM	1019.20								SM	20		27X2
	TN93-25SM	1019.21								SM	25		33X2
	TN93-30SM	1019.22								SM	30		42X2
TN93-38SM	1019.23								SM	38		48X2	

RACCORDO DI ESTREMITA DIRITTO FILETTO CONICO
MALE STUD COUPLINGS
RACOR RECTO ROSCA CONICA
GERADE EINSCHRAUBVERSCHRAUBUNGEN

TN93	CODICE 1	CODICE 2	L1	L2	L3	L4	CH1	CH2	SERIE	TUBO	DADO	M
	TN93-4LLNPT	1018.-							LLNPT	4		1/8
	TN93-5LLNPT	1018.-							LLNPT	5		1/8
	TN93-6LLNPT	1018.-							LLNPT	6		1/8
	TN93-8LLNPT	1018.-							LLNPT	8		1/8
	TN93-6LNPT	1018.04							LNPT	6		1/8
	TN93-6LNPT 1/4	1018.24							LNPT	6		1/4
	TN93-8LNPT	1018.05							LNPT	8		1/4
	TN93-8LNPT 3/8	1018.26							LNPT	8		3/8
	TN93-10LNPT 3/8	1018.29							LNPT	10		3/8
	TN93-10LNPT	1018.06							LNPT	10		1/4
	TN93-12LNPT 1/2	1018.32							LNPT	12		1/2
	TN93-12LNPT 1/4	1018.31							LNPT	12		1/4
	TN93-12LNPT	1018.07							LNPT	12		3/8
	TN93-15LNPT	1018.08							LNPT	15		1/2
	TN93-18LNPT	1018.09							LNPT	18		1/2
	TN93-22LNPT	1018.10							LNPT	22		3/4
	TN93-28LNPT	1018.11							LNPT	28		1"
	TN93-35LNPT	1018.12							LNPT	35		1.1/4
	TN93-42LNPT	1018.13							LNPT	42		1.1/2
	TN93-6SNPT	1018.14							SNPT	6		1/4
	TN93-8SNPT	1018.15							SNPT	8		1/8
	TN93-10SNPT	1018.16							SNPT	10		3/8
	TN93-10SNPT 1/4								SNPT	10		1/4
	TN93-12SNPT	1018.17							SNPT	12		3/8
	TN93-12SNPT 1/2	1018.35							SNPT	12		1/2
	TN93-12SNPT 1/4								SNPT	12		1/4
	TN93-14SNPT	1018.18							SNPT	14		1/2
	TN93-16SNPT	1018.19							SNPT	16		1/2
	TN93-20SNPT	1018.20							SNPT	20		3/4
	TN93-25SNPT	1018.21							SNPT	25		1"
	TN93-30SNPT	1018.22							SNPT	30		1.1/4
	TN93-38SNPT	1018.23							SNPT	38		1.1/2

RACCORDO DI ESTREMITA A GOMITO FILETTO CONICO
STUD ELBOWS
RACOR EN CODO ROSCA CONICA
WINKEL-EINSCHRAUBVERSCHRAUBUNGEN

TN94	CODICE 1	CODICE 2	L1	L2	L3	L4	CH1	CH2	SERIE	TUBO	DADO	M
	TN94-4LLR	1020.01							LLR	4		1/8
	TN94-5LLR	1020.-							LLR	5		1/8
	TN94-6LLR	1020.02							LLR	6		1/8
	TN94-8LLR	1020.03							LLR	8		1/8
	TN94-8LLR 1/4								LLR	8		1/4
	TN94-10LLR	1020.-							LLR	10		
	TN94-12LLR	1020.-							LLR	12		1/4
	TN94-12LLR 3/8								LLR	12		3/8
	TN94-15LLR	1020.-							LLR	15		
	TN94-15LLR 1/2								LLR	15		1/2
	TN94-18LLR	1020.-							LLR	18		
	TN94-22LLR	1020.10							LLR	22		
	TN94-6LR	1020.04							LR	6		1/8
	TN94-6LR 1/4	1020.24							LR	6		1/4
	TN94-8LR	1020.05							LR	8		1/4
	TN94-8LR 3/8	1020.26							LR	8		3/8
	TN94-10LR	1020.06							LR	10		1/4
	TN94-10LR 3/8	1020.29							LR	10		3/8
	TN94-12LR	1020.07							LR	12		3/8
	TN94-12LR 1/2	1020.32							LR	12		1/2
	TN94-12LR 1/4	1020.31							LR	12		1/4
	TN94-15LR	1020.08							LR	15		1/2
	TN94-15LR 3/8	1020.33							LR	15		3/8
	TN94-18LR	1020.09							LR	18		1/2
	TN94-22LR	1020.10							LR	22		3/4
TN94-28LR	1020.11							LR	28		1"	
TN94-35LR	1020.12							LR	35		1.1/4	
TN94-42LR	1020.13							LR	42		1.1/2	
TN94-6SR	1020.14							SR	6		1/4	
TN94-8SR	1020.15							SR	8		1/4	
TN94-10SR	1020.16							SR	10		3/8	
TN94-12SR	1020.17							SR	12		3/8	
TN94-12SR 1/2	1020.35							SR	12		1/2	
TN94-14SR	1020.18							SR	14		1/2	
TN94-16SR	1020.19							SR	16		1/2	
TN94-16SR 3/8	1020.37							SR	16		3/8	
TN94-20SR	1020.20							SR	20		3/4	
TN94-25SR	1020.21							SR	25		1"	
TN94-30SR	1020.22							SR	30		1.1/4	
TN94-38SR	1020.23							SR	38		1.1/2	
TN94-4LLM	1022.01								LLM	4		8X1
TN94-5LLM	1022.-								LLM	5		8X1
TN94-6LLM	1022.02								LLM	6		10X1
TN94-8LLM	1022.03								LLM	8		10X1

TN94	CODICE 1	CODICE 2	L1	L2	L3	L4	CH1	CH2	SERIE	TUBO	DADO	M	
	TN94-6LM	1022.04							LM	6		10X1	
	TN94-8LM	1022.05							LM	8		12X1,5	
	TN94-10LM	1022.06							LM	10		14X1,5	
	TN94-12LM	1022.07							LM	12		16X1,5	
	TN94-15LM	1022.08							LM	15		18X1,5	
	TN94-18LM	1022.09							LM	18		22X1,5	
	TN94-22LM	1022.10							LM	22		26X1,5	
	TN94-28LM	1022.11							LM	28		33X2	
	TN94-35LM	1022.12							LM	35		42X2	
	TN94-42LM	1022.13							LM	42		48X2	
	TN94-6SM	1022.14								SM	6		12X1,5
	TN94-8SM	1022.15								SM	8		14X1,5
	TN94-10SM	1022.16								SM	10		16X1,5
	TN94-12SM	1022.17								SM	12		18X1,5
	TN94-14SM	1022.18								SM	14		20X1,5
	TN94-16SM	1022.19								SM	16		22X1,5
	TN94-20SM	1022.20								SM	20		27X2
	TN94-25SM	1022.21								SM	25		33X2
	TN94-30SM	1022.22								SM	30		42X2
	TN94-38SM	1022.23								SM	38		48X2
	TN94-4LLNPT	1021.-								LLNPT	4		1/8
	TN94-5LLNPT	1021.-								LLNPT	5		1/8
	TN94-6LLNPT	1021.-								LLNPT	6		1/8
	TN94-8LLNPT	1021.-								LLNPT	8		1/8
	TN94-6LNPT	1021.04								LNPT	6		1/8
	TN94-8LNPT	1021.05								LNPT	8		1/4
	TN94-15LNPT	1021.08								LNPT	15		1/2
	TN94-18LNPT	1021.09								LNPT	18		1/2
	TN94-22LNPT	1021.10								LNPT	22		3/4
	TN94-28LNPT	1021.11								LNPT	28		1"
	TN94-35LNPT	1021.12								LNPT	35		1.1/4
	TN94-42LNPT	1021.13								LNPT	42		1.1/2
	TN94-6LNPT 1/4	1021.24								LNPT	6		1/4
	TN94-8LNPT 3/8	1021.26								LNPT	8		3/8
	TN94-10LNPT3/8	1021.29								LNPT	10		3/8
	TN94-10LNPT	1021.06								LNPT	10		1/4
	TN94-12LNPT1/2	1021.32								LNPT	12		1/2
	TN94-12LNPT1/4	1021.31								LNPT	12		1/4
TN94-12LNPT	1021.07								LNPT	12		3/8	
TN94-6SNPT	1021.14								SNPT	6		1/4	
TN94-8SNPT	1021.15								SNPT	8		1/8	
TN94-10SNPT	1021.16								SNPT	10		3/8	
TN94-10SNPT1/4									SNPT	10		1/4	
TN94-12SNPT	1021.17								SNPT	12		3/8	
TN94-12SNPT1/2	1021.35								SNPT	12		1/2	
TN94-12SNPT1/4									SNPT	12		1/4	
TN94-14SNPT	1021.18								SNPT	14		1/2	
TN94-16SNPT	1021.19								SNPT	16		1/2	
TN94-20SNPT	1021.20								SNPT	20		3/4	
TN94-25SNPT	1021.21								SNPT	25		1"	
TN94-30SNPT	1021.22								SNPT	30		1.1/4	
TN94-38SNPT	1021.23								SNPT	38		1.1/2	

RACCORDO DI ESTREMITA A GOMITO FILETTO CILINDRICO
STUD ELBOWS
RACOR EN CODO ROSCA CILINDRICA
WINKEL-EINSCHRAUBVERSCHRAUBUNGEN

TN95	CODICE 1	CODICE 2	L1	L2	L3	L4	CH1	CH2	SERIE	TUBO	DADO	M
	TN95-22LR	1023.10							LR	22		3/4
	TN95-28LR	1023.11							LR	28		1"
	TN95-35LR	1023.12							LR	35		1.1/4
	TN95-42LR	1023.13							LR	42		1.1/2
	TN95-20SR	1023.20							SR	20		3/4
	TN95-25SR	1023.21							SR	25		1"
	TN95-30SR	1023.22							SR	30		1.1/4
	TN95-38SR	1023.23							SR	38		1.1/2
	TN95-22LM	1024.10							LM	22		26X1.5
	TN95-28LM	1024.11							LM	28		33X2
	TN95-35LM	1024.12							LM	35		42X2
	TN95-42LM	1024.13							LM	42		48X2
	TN95-20SM	1024.20							SM	20		27X2
	TN95-25SM	1024.21							SM	25		33X2
	TN95-30SM	1024.22							SM	30		42X2
	TN95-38SM	1024.23							SM	38		48X2

RACCORDO DIRITTO CON ESTREMITA' FILETTATA FEMMINA
FEMALE STUD COUPLINGS
RACOR RECTO HEMBRA
GERADE AUFSCHRAUBVERSCHRAUBUNGEN

TN147	CODICE 1	CODICE 2	L1	L2	L3	L4	CH1	CH2	SERIE	TUBO	DADO	M	
	TN147-6LR	1007.04							LR	6		1/8	
	TN147-8LR	1007.05							LR	8		1/4	
	TN147-10LR	1007.06							LR	10		1/4	
	TN147-12LR	1007.07							LR	12		3/8	
	TN147-15LR	1007.08							LR	15		1/2	
	TN147-18LR	1007.09							LR	18		1/2	
	TN147-22LR	1007.10							LR	22		3/4	
	TN147-28LR	1007.11							LR	28		1"	
	TN147-35LR	1007.12							LR	35		1.1/4	
	TN147-42LR	1007.13							LR	42		1.1/2	
	TN147-6SR	1007.14								SR	6		1/4
	TN147-8SR	1007.15								SR	8		1/4
	TN147-10SR	1007.16								SR	10		3/8
	TN147-12SR	1007.17								SR	12		3/8
	TN147-14SR	1007.18								SR	14		1/2
	TN147-16SR	1007.19								SR	16		1/2
	TN147-20SR	1007.20								SR	20		3/4
	TN147-25SR	1007.21								SR	25		1"
	TN147-30SR	1007.22								SR	30		1.1/4
	TN147-38SR	1007.23								SR	38		1.1/2
	TN147-6LM	1008.04								LM	6		10X1
	TN147-8LM	1008.05								LM	8		12X1,5
	TN147-10LM	1008.06								LM	10		14X1,5
	TN147-12LM	1008.07								LM	12		16X1,5
	TN147-15LM	1008.08								LM	15		18X1,5
	TN147-18LM	1008.09								LM	18		22X1,5
	TN147-22LM	1008.10								LM	22		26X1,5
	TN147-28LM	1008.11								LM	28		33X2
	TN147-35LM	1008.12								LM	35		42X2
	TN147-42LM	1008.13								LM	42		48X2
	TN147-6SM	1008.14								SM	6		12X1,5
	TN147-8SM	1008.15								SM	8		14X1,5
	TN147-10SM	1008.16								SM	10		16X1,5
	TN147-12SM	1008.17								SM	12		18X1,5
	TN147-14SM	1008.18								SM	14		20X1,5
	TN147-16SM	1008.19								SM	16		22X1,5
	TN147-20SM	1008.20								SM	20		27X2
	TN147-25SM	1008.21								SM	25		33X2
TN147-30SM	1008.22								SM	30		42X2	
TN147-38SM	1008.23								SM	38		48X2	

RACCORDO A TEE DI ESTREMITA FILETTO CONICO CENTRALE
STUD BRANCH TEES
RACOR EN "T" TUBO - ROSCA CONICA - TUBO
T-EINSCHRAUBVERSCHRAUBUNGEN

TN96	CODICE 1	CODICE 2	L1	L2	L3	L4	CH1	CH2	SERIE	TUBO	DADO	M
	TN96-4LLR	1025.01							LLR	4		1/8
	TN96-5LLR	1025.-							LLR	5		1/8
	TN96-6LLR	1025.02							LLR	6		1/8
	TN96-8LLR	1025.03							LLR	8		1/8
	TN96-10LLR	1025.-							LLR	10		0
	TN96-12LLR	1025.-							LLR	12		1/4
	TN96-15LLR	1025.-							LLR	15		0
	TN96-18LLR	1025.-							LLR	18		0
	TN96-22LLR	1025.10							LLR	22		0
	TN96-6LR	1025.04							LR	6		1/8
	TN96-8LR	1025.05							LR	8		1/4
	TN96-10LR	1025.06							LR	10		1/4
	TN96-12LR	1025.07							LR	12		3/8
	TN96-15LR	1025.08							LR	15		1/2
	TN96-18LR	1025.09							LR	18		1/2
	TN96-22LR	1025.10							LR	22		3/4
	TN96-28LR	1025.11							LR	28		1"
	TN96-35LR	1025.12							LR	35		1.1/4
	TN96-42LR	1025.13							LR	42		1.1/2
	TN96-6SR	1025.14							SR	6		1/4
	TN96-8SR	1025.15							SR	8		1/4
	TN96-10SR	1025.16							SR	10		3/8
TN96-12SR	1025.17							SR	12		3/8	
TN96-14SR	1025.18							SR	14		1/2	
TN96-16SR	1025.19							SR	16		1/2	
TN96-20SR	1025.20							SR	20		3/4	
TN96-25SR	1025.21							SR	25		1"	
TN96-30SR	1025.22							SR	30		1.1/4	
TN96-38SR	1025.23							SR	38		1.1/2	
TN96-4LLM	1027.01								LLM	4		8X1
TN96-5LLM	1027.-								LLM	5		8X1
TN96-6LLM	1027.02								LLM	6		10X1
TN96-8LLM	1027.03								LLM	8		10X1
TN96-6LM	1027.04								LM	6		10X1
TN96-8LM	1027.05								LM	8		12X1,5
TN96-10LM	1027.06								LM	10		14X1,5
TN96-12LM	1027.07								LM	12		16X1,5
TN96-15LM	1027.08								LM	15		18X1,5
TN96-18LM	1027.09								LM	18		22X1,5
TN96-6SM	1027.14								SM	6		12X1,5
TN96-8SM	1027.15								SM	8		14X1,5
TN96-10SM	1027.16								SM	10		16X1,5
TN96-12SM	1027.17								SM	12		18X1,5
TN96-14SM	1027.18								SM	14		20X1,5
TN96-16SM	1027.19								SM	16		22X1,5

RACCORDO A TEE DI ESTREMITA FILETTO CONICO CENTRALE
STUD BRANCH TEES
RACOR EN "T" TUBO - ROSCA CONICA - TUBO
T-EINSCHRAUBVERSCHRAUBUNGEN

TN96	CODICE 1	CODICE 2	L1	L2	L3	L4	CH1	CH2	SERIE	TUBO	DADO	M
	TN96-4LLNPT	1026.-							LLNPT	4		1/8
	TN96-5LLNPT	1026.-							LLNPT	5		1/8
	TN96-6LLNPT	1026.-							LLNPT	6		1/8
	TN96-8LLNPT	1026.-							LLNPT	8		1/8
	TN96-6LNPT	1026.04							LNPT	6		1/8
	TN96-8LNPT	1026.05							LNPT	8		1/4
	TN96-10LNPT	1026.06							LNPT	10		1/4
	TN96-12LNPT	1026.07							LNPT	12		3/8
	TN96-15LNPT	1026.08							LNPT	15		1/2
	TN96-18LNPT	1026.09							LNPT	18		1/2
	TN96-22LNPT	1026.10							LNPT	22		3/4
	TN96-28LNPT	1026.11							LNPT	28		1"
	TN96-35LNPT	1026.12							LNPT	35		1.1/4
	TN96-42LNPT	1026.13							LNPT	42		1.1/2
	TN96-6SNPT	1026.14							SNPT	6		1/4
	TN96-8SNPT	1026.15							SNPT	8		1/8
	TN96-10SNPT	1026.16							SNPT	10		3/8
	TN96-12SNPT	1026.17							SNPT	12		3/8
	TN96-14SNPT	1026.18							SNPT	14		1/2
	TN96-16SNPT	1026.19							SNPT	16		1/2
	TN96-20SNPT	1026.20							SNPT	20		3/4
	TN96-25SNPT	1026.21							SNPT	25		1"
	TN96-30SNPT	1026.22							SNPT	30		1.1/4
TN96-38SNPT	1026.23							SNPT	38		1.1/2	

RACCORDO A TEE DI ESTREMITA FILETTO CILINDRICO CENTRALE
STUD BRANCH TEES
RACOR EN "T" ROSCA CILINDRICA
T-EINSCHRAUBVERSCHRAUBUNGEN

TN97	CODICE 1	CODICE 2	L1	L2	L3	L4	CH1	CH2	SERIE	TUBO	DADO	M
	TN97-22LR	1028.10							LR	22		3/4
	TN97-28LR	1028.11							LR	28		1"
	TN97-35LR	1028.12							LR	35		1.1/4
	TN97-42LR	1028.13							LR	42		1.1/2
	TN97-20SR	1028.20							SR	20		3/4
	TN97-25SR	1028.21							SR	25		1"
	TN97-30SR	1028.22							SR	30		1.1/4
	TN97-38SR	1028.23							SR	38		1.1/2
	TN97-22LM	1029.10							LM	22		26X1.5
	TN97-28LM	1029.11							LM	28		33X2
	TN97-35LM	1029.12							LM	35		42X2
	TN97-42LM	1029.13							LM	42		48X2
	TN97-20SM	1029.20							SM	20		27X2
	TN97-25SM	1029.21							SM	25		33X2
	TN97-30SM	1029.22							SM	30		42X2
	TN97-38SM	1029.23							SM	38		48X2

RACCORDO DIRITTO PER COMBINAZIONI
STUD/STANDPIPE ADAPTORS
RACOR TUBO ROSCADO CON JUNTA TORICA
GERADE AUFSTECKSTUTZEN

TN126	CODICE 1	CODICE 2	L1	L2	L3	L4	CH1	CH2	SERIE	TUBO	DADO	M	
	TN126-6LR	10CTG.04							LR	6		1/8	
	TN126-8LR	10CTG.05							LR	8		1/4	
	TN126-10LR	10CTG.06							LR	10		1/4	
	TN126-12LR	10CTG.07							LR	12		3/8	
	TN126-15LR	10CTG.08							LR	15		1/2	
	TN126-18LR	10CTG.09							LR	18		1/2	
	TN126-22LR	10CTG.10							LR	22		3/4	
	TN126-28LR	10CTG.11							LR	28		1"	
	TN126-35LR	10CTG.12							LR	35		1.1/4	
	TN126-42LR	10CTG.13							LR	42		1.1/2	
	TN126-6SR	10CTG.14								SR	6		1/4
	TN126-8SR	10CTG.15								SR	8		1/4
	TN126-10SR	10CTG.16								SR	10		3/8
	TN126-12SR	10CTG.17								SR	12		3/8
	TN126-14SR	10CTG.18								SR	14		1/2
	TN126-16SR	10CTG.19								SR	16		1/2
	TN126-20SR	10CTG.20								SR	20		3/4
	TN126-25SR	10CTG.21								SR	25		1"
	TN126-30SR	10CTG.22								SR	30		1.1/4
	TN126-38SR	10CTG.23								SR	38		1.1/2
	TN126-6LM	10CTG.04								LM	6		10X1
	TN126-8LM	10CTG.05								LM	8		12X1,5
	TN126-10LM	10CTG.06								LM	10		14X1,5
TN126-12LM	10CTG.07								LM	12		16X1,5	
TN126-15LM	10CTG.08								LM	15		18X1,5	
TN126-18LM	10CTG.09								LM	18		22X1,5	
TN126-22LM	10CTG.10								LM	22		26X1,5	
TN126-28LM	10CTG.11								LM	28		33X2	
TN126-35LM	10CTG.12								LM	35		42X2	
TN126-42LM	10CTG.13								LM	42		48X2	
TN126-6SM	10CTG.14								SM	6		12X1,5	
TN126-8SM	10CTG.15								SM	8		14X1,5	
TN126-10SM	10CTG.16								SM	10		16X1,5	
TN126-12SM	10CTG.17								SM	12		18X1,5	
TN126-14SM	10CTG.18								SM	14		20X1,5	
TN126-16SM	10CTG.19								SM	16		22X1,5	
TN126-20SM	10CTG.20								SM	20		27X2	
TN126-25SM	10CTG.21								SM	25		33X2	
TN126-30SM	10CTG.22								SM	30		42X2	
TN126-38SM	10CTG.23								SM	38		48X2	
TN126-12SNPT	10CTG.17								SNPT	12		3/8	

RACCORDO DIRITTO PER COMBINAZIONI PREMONTATO
STUD/STANDPIPE ADAPTORS
RACOR TUBO ROSCADO CON JUNTA TORICA CON TERCA Y ANILLO
GERADE AUFSTECKSTUTZEN

TN126A	CODICE 1	CODICE 2	L1	L2	L3	L4	CH1	CH2	SERIE	TUBO	DADO	M	
	TN126A-6LR	1011.04							LR	6		1/8	
	TN126A-8LR	1011.05							LR	8		1/4	
	TN126A-10LR	1011.06							LR	10		1/4	
	TN126A-12LR	1011.07							LR	12		3/8	
	TN126A-15LR	1011.08							LR	15		1/2	
	TN126A-18LR	1011.09							LR	18		1/2	
	TN126A-22LR	1011.10							LR	22		3/4	
	TN126A-28LR	1011.11							LR	28		1"	
	TN126A-35LR	1011.12							LR	35		1.1/4	
	TN126A-42LR	1011.13							LR	42		1.1/2	
	TN126A-6SR	1011.14								SR	6		1/4
	TN126A-8SR	1011.15								SR	8		1/4
	TN126A-10SR	1011.16								SR	10		3/8
	TN126A-12SR	1011.17								SR	12		3/8
	TN126A-14SR	1011.18								SR	14		1/2
	TN126A-16SR	1011.19								SR	16		1/2
	TN126A-20SR	1011.20								SR	20		3/4
	TN126A-25SR	1011.21								SR	25		1"
	TN126A-30SR	1011.22								SR	30		1.1/4
	TN126A-38SR	1011.23								SR	38		1.1/2
	TN126A-6LM	1012.04								LM	6		10X1
	TN126A-8LM	1012.05								LM	8		12X1,5
	TN126A-10LM	1012.06								LM	10		14X1,5
	TN126A-12LM	1012.07								LM	12		16X1,5
	TN126A-15LM	1012.08								LM	15		18X1,5
	TN126A-18LM	1012.09								LM	18		22X1,5
TN126A-22LM	1012.10								LM	22		26X1,5	
TN126A-28LM	1012.11								LM	28		33X2	
TN126A-35LM	1012.12								LM	35		42X2	
TN126A-42LM	1012.13								LM	42		48X2	
TN126A-6SM	1012.14								SM	6		12X1,5	
TN126A-8SM	1012.15								SM	8		14X1,5	
TN126A-10SM	1012.16								SM	10		16X1,5	
TN126A-12SM	1012.17								SM	12		18X1,5	
TN126A-14SM	1012.18								SM	14		20X1,5	
TN126A-16SM	1012.19								SM	16		22X1,5	
TN126A-20SM	1012.20								SM	20		27X2	
TN126A-25SM	1012.21								SM	25		33X2	
TN126A-30SM	1012.22								SM	30		42X2	
TN126A-38SM	1012.23								SM	38		48X2	

RACCORDO A TEE DI ESTREMITA A L FILETTO CILINDRICO
STUD BARREL TEES
RACOR EN "T" TUBO - TUBO - ROSCA CILINDRICA
L-EINSCHRAUBVERSCHRAUBUNGEN

TN129	CODICE 1	CODICE 2	L1	L2	L3	L4	CH1	CH2	SERIE	TUBO	DADO	M
	TN129-22LR	1033.10							LR	22		3/4
	TN129-28LR	1033.11							LR	28		1"
	TN129-35LR	1033.12							LR	35		1.1/4
	TN129-42LR	1033.13							LR	42		1.1/2
	TN129-20SR	1033.20							SR	20		3/4
	TN129-25SR	1033.21							SR	25		1"
	TN129-30SR	1033.22							SR	30		1.1/4
	TN129-38SR	1033.23							SR	38		1.1/2
	TN129-22LM	1034.10							LM	22		26X1.5
	TN129-28LM	1034.11							LM	28		33X2
	TN129-35LM	1034.12							LM	35		42X2
	TN129-42LM	1034.13							LM	42		48X2
	TN129-20SM	1034.20							SM	20		27X2
	TN129-25SM	1034.21							SM	25		33X2
	TN129-30SM	1034.22							SM	30		42X2
	TN129-38SM	1034.23							SM	38		48X2

RACCORDO ORIENTABILE
BANJOS
RACOR EN CODO ORIENTABLE SIN ESTRANGULACION
DROSSELFREIE SCHWENKVERSCHRAUBUNGEN

TN111	CODICE 1	CODICE 2	L1	L2	L3	L4	CH1	CH2	SERIE	TUBO	DADO	M	
	TN111-4LLR	1013.01							LLR	4		1/8	
	TN111-5LLR	1013.-							LLR	5		1/8	
	TN111-6LLR	1013.02							LLR	6		1/8	
	TN111-8LLR	1013.03							LLR	8		1/8	
	TN111-6LR	1013.04							LR	6		1/8	
	TN111-8LR	1013.05							LR	8		1/4	
	TN111-10LR	1013.06							LR	10		1/4	
	TN111-12LR	1013.07							LR	12		3/8	
	TN111-15LR	1013.08							LR	15		1/2	
	TN111-18LR	1013.09							LR	18		1/2	
	TN111-22LR	1013.10							LR	22		3/4	
	TN111-28LR	1013.11							LR	28		1"	
	TN111-35LR	1013.12							LR	35		1.1/4	
	TN111-42LR	1013.13							LR	42		1.1/2	
	TN111-6SR	1013.14							SR	6		1/4	
	TN111-8SR	1013.15							SR	8		1/4	
	TN111-10SR	1013.16							SR	10		3/8	
	TN111-12SR	1013.17							SR	12		3/8	
	TN111-14SR	1013.18							SR	14		1/2	
	TN111-16SR	1013.19							SR	16		1/2	
	TN111-20SR	1013.20							SR	20		3/4	
	TN111-25SR	1013.21							SR	25		1"	
	TN111-30SR	1013.22							SR	30		1.1/4	
	TN111-38SR	1013.23							SR	38		1.1/2	
	TN111-4LLM	1014.01								LLM	4		8X1
	TN111-5LLM	1014.-								LLM	5		8X1
	TN111-6LLM	1014.02								LLM	6		10X1
	TN111-8LLM	1014.03								LLM	8		10X1
	TN111-6LM	1014.04								LM	6		10X1
	TN111-8LM	1014.05								LM	8		12X1,5
	TN111-10LM	1014.06								LM	10		14X1,5
	TN111-12LM	1014.07								LM	12		16X1,5
	TN111-15LM	1014.08								LM	15		18X1,5
	TN111-18LM	1014.09								LM	18		22X1,5
	TN111-22LM	1014.10								LM	22		26X1,5
	TN111-28LM	1014.11								LM	28		33X2
	TN111-35LM	1014.12								LM	35		42X2
	TN111-42LM	1014.13								LM	42		48X2
TN111-6SM	1014.14								SM	6		12X1,5	
TN111-8SM	1014.15								SM	8		14X1,5	
TN111-10SM	1014.16								SM	10		16X1,5	
TN111-12SM	1014.17								SM	12		18X1,5	
TN111-14SM	1014.18								SM	14		20X1,5	
TN111-16SM	1014.19								SM	16		22X1,5	
TN111-20SM	1014.20								SM	20		27X2	
TN111-25SM	1014.21								SM	25		33X2	
TN111-30SM	1014.22								SM	30		42X2	
TN111-38SM	1014.23								SM	38		48X2	

RACCORDO ORIENTABILE
BANJOS
RACOR EN CODO ORIENTABLE SIN ESTRANGULACION
DROSSELFREIE SCHWENKVERSCHAUBUNGEN

TN131	CODICE 1	CODICE 2	L1	L2	L3	L4	CH1	CH2	SERIE	TUBO	DADO	M	
	TN131-4LLR	*.01							LLR	4		1/8	
	TN131-5LLR	*.-							LLR	5		1/8	
	TN131-6LLR	*.02							LLR	6		1/8	
	TN131-8LLR	*.03							LLR	8		1/8	
	TN131-6LR	*.04							LR	6		1/8	
	TN131-8LR	*.05							LR	8		1/4	
	TN131-10LR	*.06							LR	10		1/4	
	TN131-12LR	*.07							LR	12		3/8	
	TN131-15LR	*.08							LR	15		1/2	
	TN131-18LR	*.09							LR	18		1/2	
	TN131-22LR	*.10							LR	22		3/4	
	TN131-6SR	*.14								SR	6		1/4
	TN131-8SR	*.15								SR	8		1/4
	TN131-10SR	*.16								SR	10		3/8
	TN131-12SR	*.17								SR	12		3/8
	TN131-14SR	*.18								SR	14		1/2
	TN131-16SR	*.19								SR	16		1/2
	TN131-20SR	*.20								SR	20		3/4
	TN131-4LLM	*.01								LLM	4		8X1
	TN131-5LLM	*.-								LLM	5		8X1
TN131-6LLM	*.02								LLM	6		10X1	
TN131-8LLM	*.03								LLM	8		10X1	
TN131-6LM	*.04								LM	6		10X1	
TN131-8LM	*.05								LM	8		12X1,5	
TN131-10LM	*.06								LM	10		14X1,5	
TN131-12LM	*.07								LM	12		16X1,5	
TN131-15LM	*.08								LM	15		18X1,5	
TN131-18LM	*.09								LM	18		22X1,5	
TN131-22LM	*.10								LM	22		26X1,5	
TN131-6SM	*.14								SM	6		12X1,5	
TN131-8SM	*.15								SM	8		14X1,5	
TN131-10SM	*.16								SM	10		16X1,5	
TN131-12SM	*.17								SM	12		18X1,5	
TN131-14SM	*.18								SM	14		20X1,5	
TN131-16SM	*.19								SM	16		22X1,5	
TN131-20SM	*.20								SM	20		27X2	

RACCORDO ORIENTABILE SENZA STROZZATURA
 ROTARY FITTING WITHOUT NECK
 RACOR EN CODO ORIENTABLE SIN ESTRANGULACION
 DROSSELFREIE SCHWENKVERSCHAUBUNGEN

TN130	CODICE 1	CODICE 2	L1	L2	L3	L4	CH1	CH2	SERIE	TUBO	DADO	M
	TN130-10LR								LR	10		1/4
	TN130-15LR								LR	15		1/2
	TN130-18LR								LR	18		1/2
	TN130-22LR								LR	22		3/4
	TN130-28LR								LR	28		1"
	TN130-12SR								SR	12		3/8
	TN130-16SR								SR	16		1/2
	TN130-20SR								SR	20		3/4
	TN130-25SR								SR	25		1"
	TN130-16SM								SM	16		22X1,5

RACCORDO A TEE DI ESTREMITA A L FILETTO CONICO
STUD BARREL TEES
RACOR EN "T" TUBO - TUBO - ROSCA CONICA
L-EINSCHRAUBVERSCHRAUBUNGEN

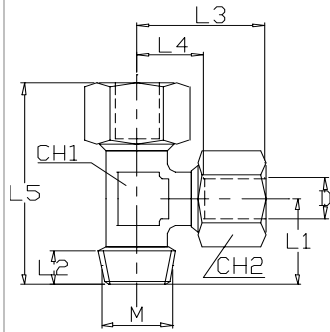

TN127	CODICE 1	CODICE 2	L1	L2	L3	L4	CH1	CH2	SERIE	TUBO	DADO	M
	TN127-4LLR	1030.01							LLR	4		1/8
	TN127-5LLR	1030.							LLR	5		1/8
	TN127-6LLR	1030.02							LLR	6		1/8
	TN127-8LLR	1030.03							LLR	8		1/8
	TN127-10LLR	1030.							LLR	10		0
	TN127-12LLR	1030.							LLR	12		1/4
	TN127-15LLR	1030.-							LLR	15		0
	TN127-18LLR	1030.-							LLR	18		0
	TN127-22LLR	1030.10							LLR	22		0
	TN127-6LR	1030.04							LR	6		1/8
	TN127-8LR	1030.05							LR	8		1/4
	TN127-10LR	1030.06							LR	10		1/4
	TN127-12LR	1030.07							LR	12		3/8
	TN127-15LR	1030.08							LR	15		1/2
	TN127-18LR	1030.09							LR	18		1/2
	TN127-22LR	1030.10							LR	22		3/4
	TN127-28LR	1030.11							LR	28		1"
	TN127-35LR	1030.12							LR	35		1.1/4
	TN127-42LR	1030.13							LR	42		1.1/2
	TN127-6SR	1030.14							SR	6		1/4
	TN127-8SR	1030.15							SR	8		1/4
	TN127-10SR	1030.16							SR	10		3/8
	TN127-12SR	1030.17							SR	12		3/8
	TN127-14SR	1030.18							SR	14		1/2
	TN127-16SR	1030.19							SR	16		1/2
	TN127-20SR	1030.20							SR	20		3/4
	TN127-25SR	1030.21							SR	25		1"
	TN127-30SR	1030.22							SR	30		1.1/4
	TN127-38SR	1030.23							SR	38		1.1/2
	TN127-4LLM	1032.01							LLM	4		8X1
	TN127-5LLM	1032.-							LLM	5		8X1
	TN127-6LLM	1032.02							LLM	6		10X1
	TN127-8LLM	1032.03							LLM	8		10X1
	TN127-6LM	1032.04							LM	6		10X1
	TN127-8LM	1032.05							LM	8		12X1,5
	TN127-10LM	1032.06							LM	10		14X1,5
	TN127-12LM	1032.07							LM	12		16X1,5
	TN127-15LM	1032.08							LM	15		18X1,5
	TN127-18LM	1032.09							LM	18		22X1,5
	TN127-6SM	1032.14							SM	6		12X1,5
	TN127-8SM	1032.15							SM	8		14X1,5
	TN127-10SM	1032.16							SM	10		16X1,5
	TN127-12SM	1032.17							SM	12		18X1,5
	TN127-14SM	1032.18							SM	14		20X1,5
	TN127-16SM	1032.19							SM	16		22X1,5

RACCORDO A TEE DI ESTREMITA A L FILETTO CONICO
STUD BARREL TEES
RACOR EN "T" TUBO - TUBO - ROSCA CONICA
L-EINSCHRAUBVERSCHRAUBUNGEN

TN127	CODICE 1	CODICE 2	L1	L2	L3	L4	CH1	CH2	SERIE	TUBO	DADO	M
	TN127-4LLNPT	1031.-							LLNPT	4		1/8
	TN127-5LLNPT	1031.-							LLNPT	5		1/8
	TN127-6LLNPT	1031.-							LLNPT	6		1/8
	TN127-8LLNPT	1031.-							LLNPT	8		1/8
	TN127-6LNPT	1031.04							LNPT	6		1/8
	TN127-8LNPT	1031.05							LNPT	8		1/4
	TN127-10LNPT	1031.06							LNPT	10		1/4
	TN127-12LNPT	1031.07							LNPT	12		3/8
	TN127-15LNPT	1031.08							LNPT	15		1/2
	TN127-18LNPT	1031.09							LNPT	18		1/2
	TN127-22LNPT	1031.10							LNPT	22		3/4
	TN127-28LNPT	1031.11							LNPT	28		1"
	TN127-35LNPT	1031.12							LNPT	35		1.1/4
	TN127-42LNPT	1031.13							LNPT	42		1.1/2
	TN127-6SNPT	1031.14							SNPT	6		1/4
	TN127-8SNPT	1031.15							SNPT	8		1/8
	TN127-10SNPT	1031.16							SNPT	10		3/8
	TN127-12SNPT	1031.17							SNPT	12		3/8
	TN127-14SNPT	1031.18							SNPT	14		1/2
	TN127-16SNPT	1031.19							SNPT	16		1/2
	TN127-20SNPT	1031.20							SNPT	20		3/4
	TN127-25SNPT	1031.21							SNPT	25		1"
	TN127-30SNPT	1031.22							SNPT	30		1.1/4
TN127-38SNPT	1031.23							SNPT	38		1.1/2	

RACCORDO ORIENTABILE DOPPIO
DOUBLE ORIENTABLE FITTING
RACOR EN CODO ORIENTABLE TUBO - MACHO CILINDRICO - TUBO
DROSSELFREIE SCHWENKVERSCHRAUBUNGEN

TN136	CODICE 1	CODICE 2	L1	L2	L3	L4	CH1	CH2	SERIE	TUBO	DADO	M	
	TN136-4LLR	1015.01							LLR	4		1/8	
	TN136-5LLR	1015.-							LLR	5		1/8	
	TN136-6LLR	1015.02							LLR	6		1/8	
	TN136-8LLR	1015.03							LLR	8		1/8	
	TN136-6LR	1015.04							LR	6		1/8	
	TN136-8LR	1015.05							LR	8		1/4	
	TN136-10LR	1015.06							LR	10		1/4	
	TN136-12LR	1015.07							LR	12		3/8	
	TN136-15LR	1015.08							LR	15		1/2	
	TN136-18LR	1015.09							LR	18		1/2	
	TN136-22LR	1015.10							LR	22		3/4	
	TN136-28LR	1015.11							LR	28		1"	
	TN136-35LR	1015.12							LR	35		1.1/4	
	TN136-42LR	1015.13							LR	42		1.1/2	
	TN136-6SR	1015.14							SR	6		1/4	
	TN136-8SR	1015.15							SR	8		1/4	
	TN136-10SR	1015.16							SR	10		3/8	
	TN136-12SR	1015.17							SR	12		3/8	
	TN136-14SR	1015.18							SR	14		1/2	
	TN136-16SR	1015.19							SR	16		1/2	
	TN136-20SR	1015.20							SR	20		3/4	
	TN136-25SR	1015.21							SR	25		1"	
	TN136-30SR	1015.22							SR	30		1.1/4	
	TN136-38SR	1015.23							SR	38		1.1/2	
	TN136-4LLM	1016.01								LLM	4		8X1
	TN136-5LLM	1016.-								LLM	5		8X1
	TN136-6LLM	1016.02								LLM	6		10X1
	TN136-8LLM	1016.03								LLM	8		10X1
	TN136-6LM	1016.04								LM	6		10X1
	TN136-8LM	1016.05								LM	8		12X1,5
	TN136-10LM	1016.06								LM	10		14X1,5
	TN136-12LM	1016.07								LM	12		16X1,5
	TN136-15LM	1016.08								LM	15		18X1,5
	TN136-18LM	1016.09								LM	18		22X1,5
	TN136-22LM	1016.10								LM	22		26X1,5
	TN136-28LM	1016.11								LM	28		33X2
	TN136-35LM	1016.12								LM	35		42X2
	TN136-42LM	1016.13								LM	42		48X2
TN136-6SM	1016.14								SM	6		12X1,5	
TN136-8SM	1016.15								SM	8		14X1,5	
TN136-10SM	1016.16								SM	10		16X1,5	
TN136-12SM	1016.17								SM	12		18X1,5	
TN136-14SM	1016.18								SM	14		20X1,5	
TN136-16SM	1016.19								SM	16		22X1,5	
TN136-20SM	1016.20								SM	20		27X2	
TN136-25SM	1016.21								SM	25		33X2	
TN136-30SM	1016.22								SM	30		42X2	
TN136-38SM	1016.23								SM	38		48X2	

RACCORDO A SALDARE
WELDING BULKHEAD CONNECTIONS
RACOR PASATABIQUE PARA SOLDAR
EINSCHWEISS-SCHOTTVERSCHRAUBUNGEN

TN117	CODICE 1	CODICE 2	L1	L2	L3	L4	CH1	CH2	SERIE	TUBO	DADO	M
	TN117-6L	1056.04							L	6		
	TN117-8L	1056.05							L	8		
	TN117-10L	1056.06							L	10		
	TN117-12L	1056.07							L	12		
	TN117-15L	1056.08							L	15		
	TN117-18L	1056.09							L	18		
	TN117-22L	1056.10							L	22		
	TN117-28L	1056.11							L	28		
	TN117-35L	1056.12							L	35		
	TN117-42L	1056.13							L	42		
	TN117-6S	1056.14							S	6		
	TN117-8S	1056.15							S	8		
	TN117-10S	1056.16							S	10		
	TN117-12S	1056.17							S	12		
	TN117-14S	1056.18							S	14		
	TN117-16S	1056.19							S	16		
	TN117-20S	1056.20							S	20		
	TN117-25S	1056.21							S	25		
	TN117-30S	1056.22							S	30		
	TN117-38S	1056.23							S	38		

RACCORDO DIRITTO SALDABILE
WELDING BOSSES
RACOR RECTO PARA SOLDAR
GERADE ANSCHWELSSVERSCHRAUBUNGEN

TN91	CODICE 1	CODICE 2	L1	L2	L3	L4	CH1	CH2	SERIE	TUBO	DADO	_A_
	TN91-6L	1055.04							L	6		
	TN91-8L	1055.05							L	8		
	TN91-10L	1055.06							L	10		
	TN91-12L	1055.07							L	12		
	TN91-15L	1055.08							L	15		
	TN91-18L	1055.09							L	18		
	TN91-22L	1055.10							L	22		
	TN91-28L	1055.11							L	28		
	TN91-35L	1055.12							L	35		
	TN91-42L	1055.13							L	42		
	TN91-6S	1055.14							S	6		
	TN91-8S	1055.15							S	8		
	TN91-10S	1055.16							S	10		
	TN91-12S	1055.17							S	12		
	TN91-14S	1055.18							S	14		
	TN91-16S	1055.19							S	16		
	TN91-20S	1055.20							S	20		
	TN91-25S	1055.21							S	25		
	TN91-30S	1055.22							S	30		
	TN91-38S	1055.23							S	38		

OGIVA A SILDARE CON O-RING
WELDING NIPPLES WITH O-RING SEAL
BOQUILLA PARA SOLDAR
SCHWEISSNIPPEL MIT O-RING-ABDICHTUNG

TN299	CODICE 1	CODICE 2	L1	L2	L3	L4	CH1	CH2	SERIE	TUBO	DADO	M
	TN299B-10X1,5											
	TN299B-12X1,5											
	TN299A-12X1,5											
	TN299B-12X2											
	TN299B-14X2											
	TN299B-16X2											
	TN299B-16X2,5											
	TN299B-20X2,5											
	TN299B-20X3											
	TN299B-25X3											
	TN299B-25X4											
	TN299B-30X3											
	TN299B-30X4											
	TN299B-30X5											
	TN299B-38X4											
	TN299B-38X5											
	TN299B-38X6											
	TN299B-50X6											
TN299B-50X7												
TN299B-50X8												

RACCORDO INTERMEDIO DIRITTO PORTAMANOMETRO
STRAIGHT COUPLING
RACOR UNION RECTA TUBO - TUBO PARA MANOMETRO
GERADE VERSCHRAUBUNGEN

TN98K	CODICE 1	CODICE 2	L1	L2	L3	L4	CH1	CH2	SERIE	TUBO	DADO	M	
	TN98K-6L	*.04							L	6			
	TN98K-8L	*.05							L	8			
	TN98K-10L	*.06							L	10			
	TN98K-12L	*.07							L	12			
	TN98K-15L	*.08							L	15			
	TN98K-18L	*.09							L	18			
	TN98K-22L	*.10							L	22			
	TN98K-28L	*.11							L	28			
	TN98K-35L	*.12							L	35			
	TN98K-42L	*.13							L	42			
	TN98K-6S	*.14								S	6		
	TN98K-8S	*.15								S	8		
	TN98K-10S	*.16								S	10		
	TN98K-12S	*.17								S	12		
	TN98K-14S	*.18								S	14		
	TN98K-16S	*.19								S	16		
	TN98K-20S	*.20								S	20		
	TN98K-25S	*.21								S	25		
	TN98K-30S	*.22								S	30		
	TN98K-38S	*.23								S	38		

RACCORDO PER MANOMETRO
GAUGE COUPLINGS
RACOR PARA MANOMETRO
MANOMETER-VERSCHRAUBUNGEN

TN103	CODICE 1	CODICE 2	L1	L2	L3	L4	CH1	CH2	SERIE	TUBO	DADO	M	
	TN103-4LL	1059.01							LL	4			
	TN103-6L	1059.04							L	6			
	TN103-8L	1059.05							L	8			
	TN103-10L	1059.06							L	10			
	TN103-12L	1059.07							L	12			
	TN103-6S	1059.14							S	6			
	TN103-8S	1059.15							S	8			
	TN103-10S	1059.16							S	10			
	TN103-12S	1059.17							S	12			
	TN103-14S	1059.18							S	14			

RACCORDO INTERMEDIO DIRITTO DADO SPINATO
STRAIGHT COUPLING WITH O-RING
RACOR UNION
GERADES MITTELSTUCK MIT O-RING

TN400	CODICE 1	CODICE 2	L1	L2	L3	L4	CH1	CH2	SERIE	TUBO	DADO	M	
	TN400-6L	6035.04							L	6			
	TN400-8L	6035.05							L	8			
	TN400-10L	6035.06							L	10			
	TN400-12L	6035.07							L	12			
	TN400-15L	6035.08							L	15			
	TN400-18L	6035.09							L	18			
	TN400-22L	6035.10							L	22			
	TN400-28L	6035.11							L	28			
	TN400-35L	6035.12							L	35			
	TN400-42L	6035.13							L	42			
	TN400-6S	6035.14							S	6			
	TN400-8S	6035.15							S	8			
	TN400-10S	6035.16							S	10			
	TN400-12S	6035.17							S	12			
	TN400-14S	6035.18							S	14			
	TN400-16S	6035.19							S	16			
	TN400-20S	6035.20							S	20			
	TN400-25S	6035.21							S	25			
	TN400-30S	6035.22							S	30			
	TN400-38S	6035.23							S	38			

RACCORDO ORIENTABILE A GOMITO CON O-RING DADO SPINATO
ANGULAR ROTARY FITTING WITH O-RING SEAL
RACOR EN CODO REGULABLE
EINSTELLBARE WINKEL-ANSCHLUSSSTUTZEN MIT O-RING-ABDICHTUNG

TN419	CODICE 1	CODICE 2	L1	L2	L3	L4	CH1	CH2	SERIE	TUBO	DADO	M
	TN419-6L	6035.04							L	6		
	TN419-8L	6035.05							L	8		
	TN419-10L	6035.06							L	10		
	TN419-12L	6035.07							L	12		
	TN419-15L	6035.08							L	15		
	TN419-18L	6035.09							L	18		
	TN419-22L	6035.10							L	22		
	TN419-28L	6035.11							L	28		
	TN419-35L	6035.12							L	35		
	TN419-42L	6035.13							L	42		
	TN419-6S	6035.14							S	6		
	TN419-8S	6035.15							S	8		
	TN419-10S	6035.16							S	10		
	TN419-12S	6035.17							S	12		
	TN419-14S	6035.18							S	14		
	TN419-16S	6035.19							S	16		
	TN419-20S	6035.20							S	20		
	TN419-25S	6035.21							S	25		
	TN419-30S	6035.22							S	30		
	TN419-38S	6035.23							S	38		

RACCORDO A TEE ORIENTABILE AL CENTRO CON DADO SPINATO
ROTARY FITTING A TEES WITH O-RING SEAL
RACOR EN "T" REGULABLE
EINSTELLBARE T-ANSCHLUSSSTUTZEN MIT O-RING-ABDICHTUNG

TN420	CODICE 1	CODICE 2	L1	L2	L3	L4	CH1	CH2	SERIE	TUBO	DADO	M
	TN420-6L	6050.04							L	6		
	TN420-8L	6050.05							L	8		
	TN420-10L	6050.06							L	10		
	TN420-12L	6050.07							L	12		
	TN420-15L	6050.08							L	15		
	TN420-18L	6050.09							L	18		
	TN420-22L	6050.10							L	22		
	TN420-28L	6050.11							L	28		
	TN420-35L	6050.12							L	35		
	TN420-42L	6050.13							L	42		
	TN420-6S	6050.14							S	6		
	TN420-8S	6050.15							S	8		
	TN420-10S	6050.16							S	10		
	TN420-12S	6050.17							S	12		
	TN420-14S	6050.18							S	14		
	TN420-16S	6050.19							S	16		
	TN420-20S	6050.20							S	20		
	TN420-25S	6050.21							S	25		
	TN420-30S	6050.22							S	30		
	TN420-38S	6050.23							S	38		

RACCORDO A TEE ORIENTABILE A LATO CON DADO SPINATO
ROTARY FITTING A L WITH O-RING SEAL
RACOR EN "T" REGULABLE
EINSTELLBARE L-ANSCHLUSSSTUTZEN MIT O-RING-ABDICHTUNG

TN421			L1	L2	L3	L4	CH1	CH2	SERIE	TUBO	DADO	M
	CODICE 1	CODICE 2										
	TN421-6L	6046.04							L	6		
	TN421-8L	6046.05							L	8		
	TN421-10L	6046.06							L	10		
	TN421-12L	6046.07							L	12		
	TN421-15L	6046.08							L	15		
	TN421-18L	6046.09							L	18		
	TN421-22L	6046.10							L	22		
	TN421-28L	6046.11							L	28		
	TN421-35L	6046.12							L	35		
	TN421-42L	6046.13							L	42		
	TN421-6S	6046.14							S	6		
	TN421-8S	6046.15							S	8		
	TN421-10S	6046.16							S	10		
	TN421-12S	6046.17							S	12		
	TN421-14S	6046.18							S	14		
	TN421-16S	6046.19							S	16		
	TN421-20S	6046.20							S	20		
	TN421-25S	6046.21							S	25		
	TN421-30S	6046.22							S	30		
	TN421-38S	6046.23							S	38		

RACCORDO DIRITTO PER COMBINAZIONI PREMONTATO CON DADO SPINATO
STUD STANDPIPE ADAPTORS PACKING RING/O-RING SEAL
RACOR TUBO ROSCADO CON JUNTA TORICA CON TERCA Y ANILLO
GERADE AUFSTECKSTUTZEN GUMMIDICHTUNG/O-RING-ABDICHTUNG

TN426			L1	L2	L3	L4	CH1	CH2	SERIE	TUBO	DADO	_G_
	CODICE 1	CODICE 2										
	TN426-6L	6005.04							L	6		
	TN426-8L	6005.05							L	8		
	TN426-10L	6005.06							L	10		
	TN426-12L	6005.07							L	12		
	TN426-15L	6005.08							L	15		
	TN426-18L	6005.09							L	18		
	TN426-22L	6005.10							L	22		
	TN426-28L	6005.11							L	28		
	TN426-35L	6005.12							L	35		
	TN426-42L	6005.13							L	42		
	TN426-6S	6005.14							S	6		
	TN426-8S	6005.15							S	8		
	TN426-10S	6005.16							S	10		
	TN426-12S	6005.17							S	12		
	TN426-14S	6005.18							S	14		
	TN426-16S	6005.19							S	16		
	TN426-20S	6005.20							S	20		
	TN426-25S	6005.21							S	25		
	TN426-30S	6005.22							S	30		
	TN426-38S	6005.23							S	38		

TAPPO FILETTATO CONICO CON ESAGONO INCASSATO
INNER HEXAGON PLUG
TAPON CONICO
VERSCHLOSSTOPFEN MIT INNENSECHSKANT

TN192	CODICE 1	CODICE 2	L1	L2	L3	L4	CH1	CH2	SERIE	TUBO	DADO	_G_	
	TN192-1/8R								R			1/8	
	TN192-1/4R								R			1/4	
	TN192-3/8R								R			3/8	
	TN192-1/2R								R			1/2	
	TN192-5/8R								R			5/8	
	TN192-3/4R								R			3/4	
	TN192-1"R								R			1	
	TN192-1 1/4"R								R			1 1/4	
	TN192-1 1/2"R								R			1 1/2	
	TN192-1/16NPT									NPT			1/16
	TN192-1/8NPT									NPT			1/8
	TN192-1/4NPT									NPT			1/4
	TN192-3/8NPT									NPT			3/8
	TN192-1/2NPT									NPT			1/2
	TN192-3/4NPT									NPT			3/4
	TN192-1"NPT									NPT			1
	TN192-1 1/4"NPT									NPT			1 1/4
	TN192-1 1/2"NPT									NPT			1 1/2

RACCORDO DI RIDUZIONE FILETTATO CILINDRICO CON GUARNIZIONE
MALE/FEMALE STUD ADAPTORS
REDUCCIONES CON ROSCA MACHO - HEMBRA CON JUNTA TORICA
GEVINDERREDUZIERUNGEN

TN141	CODICE 1	CODICE 2	L1	L2	L3	L4	CH1	CH2	SERIE	TUBO	DADO	AxB
	TN141-1"X1/2R								R			1"X1/2
	TN141-1"X1/4R								R			1"X1/4
	TN141-1"X112R								R			1"X112
	TN141-1"X114R								R			1"X114
	TN141-1"X3/4R								R			1"X3/4
	TN141-1"X3/8R								R			1"X3/8
	TN141-1/2X1"R								R			1/2X1"
	TN141-1/2X1/4R								R			1/2X1/4
	TN141-1/2X1/8R								R			1/2X1/8
	TN141-1/2X114R								R			1/2X114
	TN141-1/2X3/4R								R			1/2X3/4
	TN141-1/2X3/8R								R			1/2X3/8
	TN141-1/4X1/2R								R			1/4X1/2
	TN141-1/4X1/8R								R			1/4X1/8
	TN141-1/4X3/4R								R			1/4X3/4
	TN141-1/4X3/8R								R			1/4X3/8
	TN141-1/8X1/4R								R			1/8X1/4
	TN141-1/8X3/8R								R			1/8X3/8
	TN141-112X1"R								R			112X1"
	TN141-112X1/2R								R			112X1/2
	TN141-112X114R								R			112X114
	TN141-112X3/4R								R			112X3/4
	TN141-114X1"R								R			114X1"
	TN141-114X1/2R								R			114X1/2
	TN141-114X112R								R			114X112
	TN141-114X3/4R								R			114X3/4
	TN141-3/4X1"R								R			3/4X1"
	TN141-3/4X1/2R								R			3/4X1/2
	TN141-3/4X1/4R								R			3/4X1/4
	TN141-3/4X112R								R			3/4X112
	TN141-3/4X114R								R			3/4X114
	TN141-3/4X3/8R								R			3/4X3/8
TN141-3/8X1/2R								R			3/8X1/2	
TN141-3/8X1/4R								R			3/8X1/4	
TN141-3/8X1/8R								R			3/8X1/8	
TN141-3/8X3/4R								R			3/8X3/4	

TAPPO DI CHIUSURA TUBICO
TUBE PLUG FOR CONNECTION FOR TN 81
TAPON DE CIERRE CON JUNTA TORICA
VERSCHLUSSBUTZEN FUR KONEN TN 81

TN188	CODICE 1	CODICE 2	L1	L2	L3	L4	CH1	CH2	SERIE	TUBO	DADO	M
	TN188-6L	1058.04							L	6		
	TN188-8L	1058.05							L	8		
	TN188-10L	1058.06							L	10		
	TN188-12L	1058.07							L	12		
	TN188-15L	1058.08							L	15		
	TN188-18L	1058.09							L	18		
	TN188-22L	1058.10							L	22		
	TN188-28L	1058.11							L	28		
	TN188-35L	1058.12							L	35		
	TN188-42L	1058.13							L	42		
	TN188-6S	1058.14							S	6		
	TN188-8S	1058.15							S	8		
	TN188-10S	1058.16							S	10		
	TN188-12S	1058.17							S	12		
	TN188-14S	1058.18							S	14		
	TN188-16S	1058.19							S	16		
	TN188-20S	1058.20							S	20		
	TN188-25S	1058.21							S	25		
	TN188-30S	1058.22							S	30		
	TN188-38S	1058.23							S	38		

TAPPO CILINDRICO CON BATTUTA ED ESAGONO INCASSATO
INNER HEXAGON PLUG
TAPON DE CIERRE ALLEN CON JUNTA TORICA
VERSCHLUSSTOPFEN MIT INNENSECHSKANT

TN185	CODICE 1	CODICE 2	L1	L2	L3	L4	CH1	CH2	SERIE	TUBO	DADO	_G_
	TN185-1/8R	1076.01							R			1/8
	TN185-1/4R	1076.02							R			1/4
	TN185-3/8R	1076.03							R			3/8
	TN185-1/2R	1076.04							R			1/2
	TN185-3/4R	1076.05							R			3/4
	TN185-1"R	1076.06							R			1
	TN185-1 1/4"R	1076.07							R			1.1/4
	TN185-1 1/2"R	1076.08							R			1.1/2
	TN185-10X1M	1077.01							M			10X1
	TN185-12X1,5M	1077.02							M			12X1,5
	TN185-14X1,5M	1077.03							M			14X1,5
	TN185-16X1,5M	1077.04							M			16X1,5
	TN185-18X1,5M	1077.05							M			18X1,5
	TN185-20X1,5M	1077.06							M			20X1,5
	TN185-22X1,5M	1077.07							M			22X1,5
	TN185-26X1,5M	1077.08							M			26X1,5
	TN185-27X2M	1077.09							M			27X2
	TN185-33X2M	1077.10							M			33X2
	TN185-42X2M	1077.11							M			42X2
	TN185-48X2M	1077.12							M			48X2

TAPPO MASCHIO
MALE PLUG
TAPON DE CIERRE ALLEN
VERSCHLUSSBUTZEN

TN05

CODICE 1

CODICE 2

L1

L2

L3

L4

CH1

CH2

SERIE

TUBO

DADO

F

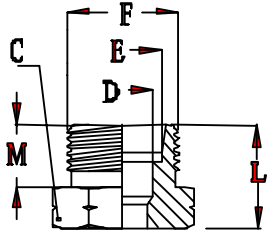

TN05-4LL

TN05-5LL

TN05-6LL

TN05-8LL

TN05-10LL

TN05-12LL

TN05-15LL

TN05-18LL

TN05-22LL

TN05-6L

TN05-8L

TN05-10L

TN05-12L

TN05-15L

TN05-18L

TN05-22L

TN05-28L

TN05-35L

TN05-42L

TN05-6S

TN05-8S

TN05-10S

TN05-12S

TN05-14S

TN05-16S

TN05-20S

TN05-25S

TN05-30S

TN05-38S

LL

4

8X1

8X1

LL

5

10X1

10X1

LL

6

10X1

10X1

LL

8

12X1

12X1

LL

10

14X1

14X1

LL

12

16X1

16X1

LL

15

0

0

LL

18

0

0

LL

22

0

0

L

6

12X1,5

12X1,5

L

8

14X1,5

14X1,5

L

10

16X1,5

16X1,5

L

12

18X1,5

18X1,5

L

15

22X1,5

22X1,5

L

18

26X1,5

26X1,5

L

22

30X2

30X2

L

28

36X2

36X2

L

35

45X2

45X2

L

42

52X2

52X2

S

6

14X1,5

14X1,5

S

8

16X1,5

16X1,5

S

10

18X1,5

18X1,5

S

12

20X1,5

20X1,5

S

14

22X1,5

22X1,5

S

16

24X1,5

24X1,5

S

20

30X2

30X2

S

25

36X2

36X2

S

30

42X2

42X2

S

38

52X2

52X2